



# Handheld Acoustic Imaging Camera

User Manual



Contact Us

## Legal Information

©2023 Hangzhou Microimage Software Co., Ltd. All rights reserved.

### About this Manual

The Manual includes instructions for using and managing the Product. Pictures, charts, images and all other information hereinafter are for description and explanation only. The information contained in the Manual is subject to change, without notice, due to firmware updates or other reasons. Please find the latest version of this Manual at the HIKMICRO website (<http://www.hikmicrotech.com>).

Please use this Manual with the guidance and assistance of professionals trained in supporting the Product.

### Trademarks



**HIKMICRO**

and other HIKMICRO's trademarks and logos are the properties of HIKMICRO in various jurisdictions.

**HDMI**<sup>™</sup>: The terms HDMI and HDMI High-Definition Multimedia Interface, and the HDMI Logo are trademarks or registered trademarks of HDMI Licensing Administrator, Inc. in the United States and other countries. Other trademarks and logos mentioned are the properties of their respective owners.

### Disclaimer

TO THE MAXIMUM EXTENT PERMITTED BY APPLICABLE LAW, THIS MANUAL AND THE PRODUCT DESCRIBED, WITH ITS HARDWARE, SOFTWARE AND FIRMWARE, ARE PROVIDED "AS IS" AND "WITH ALL FAULTS AND ERRORS". HIKMICRO MAKES NO WARRANTIES, EXPRESS OR IMPLIED, INCLUDING WITHOUT LIMITATION, MERCHANTABILITY, SATISFACTORY QUALITY, OR FITNESS FOR A PARTICULAR PURPOSE. THE USE OF THE PRODUCT BY YOU IS AT YOUR OWN RISK. IN NO EVENT WILL HIKMICRO BE LIABLE TO YOU FOR ANY SPECIAL, CONSEQUENTIAL, INCIDENTAL, OR INDIRECT DAMAGES, INCLUDING, AMONG OTHERS, DAMAGES FOR LOSS OF BUSINESS PROFITS, BUSINESS INTERRUPTION, OR LOSS OF DATA, CORRUPTION OF SYSTEMS, OR LOSS OF DOCUMENTATION, WHETHER BASED ON BREACH OF CONTRACT, TORT (INCLUDING NEGLIGENCE), PRODUCT LIABILITY, OR OTHERWISE, IN CONNECTION WITH THE USE OF THE PRODUCT, EVEN IF HIKMICRO HAS BEEN ADVISED OF THE POSSIBILITY OF SUCH DAMAGES OR LOSS.

YOU ACKNOWLEDGE THAT THE NATURE OF THE INTERNET PROVIDES FOR INHERENT SECURITY RISKS, AND HIKMICRO SHALL NOT TAKE ANY RESPONSIBILITIES FOR ABNORMAL OPERATION, PRIVACY LEAKAGE OR OTHER DAMAGES RESULTING FROM CYBER-ATTACK, HACKER ATTACK, VIRUS INFECTION, OR OTHER INTERNET SECURITY RISKS; HOWEVER, HIKMICRO WILL PROVIDE TIMELY TECHNICAL SUPPORT IF REQUIRED.

YOU AGREE TO USE THIS PRODUCT IN COMPLIANCE WITH ALL APPLICABLE LAWS, AND YOU ARE SOLELY RESPONSIBLE FOR ENSURING THAT YOUR USE CONFORMS TO THE APPLICABLE LAW. ESPECIALLY, YOU ARE RESPONSIBLE, FOR USING THIS PRODUCT IN A MANNER THAT DOES NOT INFRINGE ON THE RIGHTS OF THIRD PARTIES, INCLUDING WITHOUT LIMITATION, RIGHTS OF PUBLICITY, INTELLECTUAL PROPERTY RIGHTS, OR DATA PROTECTION AND OTHER PRIVACY RIGHTS. YOU SHALL NOT USE THIS PRODUCT FOR ANY PROHIBITED END-USES, INCLUDING THE DEVELOPMENT OR PRODUCTION OF WEAPONS OF MASS DESTRUCTION, THE DEVELOPMENT OR PRODUCTION OF CHEMICAL OR BIOLOGICAL WEAPONS, ANY ACTIVITIES IN THE CONTEXT RELATED TO ANY NUCLEAR EXPLOSIVE OR UNSAFE NUCLEAR FUEL-CYCLE, OR IN SUPPORT OF HUMAN RIGHTS ABUSES.

IN THE EVENT OF ANY CONFLICTS BETWEEN THIS MANUAL AND THE APPLICABLE LAW, THE LATTER PREVAILS.

## Regulatory Information

---

**These clauses apply only to the products bearing the corresponding mark or information.**

---

### FCC Compliance Statement

Please take attention that changes or modification not expressly approved by the party responsible for compliance could void the user's authority to operate the equipment.

This device complies with Part 15 of the FCC Rules. Operation is subject to the following two conditions:

- (1) This device may not cause harmful interference, and
- (2) This device must accept any interference received, including interference that may cause undesired operation.

This equipment complies with FCC radiation exposure limits set forth for an uncontrolled environment.

Note: This equipment has been tested and found to comply with the limits for a Class A digital device, pursuant to part 15 of the FCC Rules. These limits are designed to provide reasonable protection against harmful interference when the equipment is operated in a commercial environment. This equipment generates, uses, and can radiate radio frequency energy and, if not installed and used in accordance with the instruction manual, may cause harmful interference to radio communications. Operation of this equipment in a residential area is likely to cause harmful interference in which case the user will be required to correct the interference at his own expense.

### EU/UK Conformity Statement



This product and - if applicable - the supplied accessories too are marked with "CE" and comply therefore with the applicable harmonized European standards listed under the Directive 2014/30/EU (EMCD), Directive 2014/35/EU (LVD), Directive 2011/65/EU (RoHS).



This product and - if applicable - the supplied accessories too are marked with "UKCA" and comply therefore with the following directives: Radio Equipment Regulations 2017, Electromagnetic Compatibility Regulations 2016, Electrical Equipment (Safety) Regulations 2016, the Restriction of the Use of Certain Hazardous Substances in Electrical and Electronic

Equipment Regulations 2012.

### Restrictions in the 5 GHz band:

According to Article 10 (10) of Directive 2014/53/EU, when operating in the 5150 to 5350 MHz frequency range, this device is restricted to indoor use in: Austria (AT), Belgium (BE), Bulgaria (BG), Croatia (HR), Cyprus (CY), the Czech Republic (CZ), Denmark (DK), Estonia (EE), Finland (FI), France (FR), Germany (DE), Greece (EL), Hungary (HU), Iceland (IS), Ireland (IE), Italy (IT), Latvia (LV), Liechtenstein (LI), Lithuania (LT), Luxembourg (LU), Malta (MT), Netherlands (NL), Northern Ireland (UK(NI)), Norway (NO), Poland (PL), Portugal (PT), Romania (RO), Slovakia (SK), Slovenia (SI), Spain (ES), Sweden (SE), Switzerland (CH), and Turkey (TR).

In accordance with the Radio Equipment Regulations 2017 in the UK, the device working in the 5150 to 5350 MHz frequency range is restricted to indoor use in the United Kingdom.

### Frequency Bands and Power (for CE/UKCA)

The frequency bands and modes and transmitting power (radiated and/or conducted) nominal limits applicable to the following radio equipment are as follows:

**Wi-Fi:** 2.4 GHz (2.4 GHz to 2.4835 GHz): 20 dBm; 5 GHz (5.15 GHz to 5.25 GHz): 23 dBm; 5 GHz (5.25 GHz to 5.35 GHz): 23 dBm; 5 GHz (5.47 GHz to 5.725GHz): 23 dBm; 5 GHz (5.725 GHz to 5.85 GHz): 14 dBm

Use the power adapter provided by a qualified manufacturer. Refer to the product specification for detailed

power requirements.

Use the battery provided by a qualified manufacturer. Refer to the product specification for detailed battery requirements.



Directive 2012/19/EU (WEEE Directive): Products marked with this symbol cannot be disposed of as unsorted municipal waste in the European Union. For proper recycling, return this product to your local supplier upon the purchase of equivalent new equipment, or dispose of it at designated collection points. For more information see: [www.recyclethis.info](http://www.recyclethis.info)

According to the Waste Electrical and Electronic Equipment Regulations 2013: Products marked with this symbol cannot be disposed of as unsorted municipal waste in the United Kingdom. For proper recycling, return this product to your local supplier upon the purchase of equivalent new equipment, or dispose of it at designated collection points. For more information see: [www.recyclethis.info](http://www.recyclethis.info).



Directive 2006/66/EC and its amendment 2013/56/EU (Battery Directive): This product contains a battery that cannot be disposed of as unsorted municipal waste in the European Union. See the product documentation for specific battery information. The battery is marked with this symbol, which may include lettering to indicate cadmium (Cd), lead (Pb), or mercury (Hg). For proper recycling, return the battery to your supplier or to a designated collection point. For more information see: [www.recyclethis.info](http://www.recyclethis.info).

According to the Batteries and Accumulators (Placing on the Market) Regulations 2008 and the Waste Batteries and Accumulators Regulations 2009: This product contains a battery that cannot be disposed of as unsorted municipal waste in the United Kingdom. See the product documentation for specific battery information. The battery is marked with this symbol, which may include lettering to indicate cadmium (Cd), lead (Pb), or mercury (Hg). For proper recycling, return the battery to your supplier or to a designated collection point. For more information see: [www.recyclethis.info](http://www.recyclethis.info).

### Industry Canada ICES-003 Compliance

This device meets the CAN ICES-003 (A)/NMB-003(A) standards requirements.

This device complies with Industry Canada licence-exempt RSS standard(s). Operation is subject to the following two conditions:

- (1) this device may not cause interference, and
- (2) this device must accept any interference, including interference that may cause undesired operation of the device.

Le présent appareil est conforme aux CNR d'Industrie Canada applicables aux appareils radioexempts de licence. L'exploitation est autorisée aux deux conditions suivantes :

- (1) l'appareil ne doit pas produire de brouillage, et
- (2) l'utilisateur de l'appareil doit accepter tout brouillage radioélectrique subi, même si le brouillage est susceptible d'en compromettre le fonctionnement.

For this device, please pay attention to the following notes when the device is operating in 5 GHz:

- (i) The device for operation in the band 5150-5250 MHz is only for indoor use to reduce the potential for harmful interference to co-channel mobile satellite systems;
  - (ii) The maximum antenna gain permitted for devices in the bands 5250-5350 MHz and 5470-5725 MHz shall comply with the e.i.r.p. limit; and
  - (iii) The maximum antenna gain permitted for devices in the band 5725-5825 MHz shall comply with the e.i.r.p. limits specified for point-to-point and non point-to-point operation as appropriate.
- (i) Les dispositifs fonctionnant dans la bande 5150-5250 MHz sont réservés uniquement pour une utilisation à l'intérieur afin de réduire les risques de brouillage préjudiciable aux systèmes de satellites mobiles utilisant les mêmes canaux.
- (ii) Le gain d'antenne maximal autorisé pour les appareils dans les bandes 5250-5350 MHz et 5470-5725 MHz doivent respecter le pire limiter; et

(iii) Le gain d'antenne maximal autorisé pour les appareils dans la bande 5725-5825 MHz doivent respecter le pire limites spécifiées pour le point-à-point et l'exploitation non point à point, le cas échéant.

Users should also be advised that high-power radars are allocated as primary users (i.e. priority users) of the bands 5250-5350 MHz and 5650-5850 MHz and that these radars could cause interference and/or damage to LE-LAN devices.



Les utilisateurs de radars de haute puissance sont désignés utilisateurs principaux (c.-à-d., qu'ils ont la priorité) pour les bandes 5250-5350 MHz et 5650-5850 MHz et que ces radars pourraient causer du brouillage et/ou des dommages aux dispositifs LAN-EL.

**KC**

A급 기기: 이 기기는 업무용(A급) 전자파적합기기로서 판매자 또는 사용자는 이 점을 주의하시기바라며, 가정 외의 지역에서 사용하는 것을 목적으로 합니다.

## Symbol Conventions

The symbols that may be found in this document are defined as follows.

Symbol	Description
 <b>Danger</b>	Indicates a hazardous situation which, if not avoided, will or could result in death or serious injury.
 <b>Caution</b>	Indicates a potentially hazardous situation which, if not avoided, could result in equipment damage, data loss, performance degradation, or unexpected results.
 <b>Note</b>	Provides additional information to emphasize or supplement important points of the main text.

## Safety Instruction

These instructions are intended to ensure that user can use the product correctly to avoid danger or property loss.

### Laws and Regulations

- Use of the product must be in strict compliance with the local electrical safety regulations.

### Transportation

- Keep the device in original or similar packaging while transporting it.
- Keep all wrappers after unpacking them for future use. In case of any failure occurred, you need to return the device to the factory with the original wrapper. Transportation without the original wrapper may result in damage on the device and the company shall not take any responsibilities.
- DO NOT drop the product or subject it to physical shock. Keep the device away from magnetic interference.

### Power Supply

- Please purchase the charger by yourself. Input voltage should meet the Limited Power Source (5 VDC, 2 A) according to the IEC61010-1 standard. Please refer to technical specifications for detailed information.
- Make sure the plug is properly connected to the power socket.
- DO NOT connect multiple devices to one power adapter, to avoid over-heating or fire hazards caused by overload.

### Battery

- Improper use or replacement of the battery may result in explosion hazard. Replace with the same or equivalent type only. Dispose of used batteries in conformance with the instructions provided by the battery manufacturer.
- The built-in battery cannot be dismantled. Please contact the manufacture for repair if necessary.
- For long-term storage of the battery, make sure it is fully charged every half year to ensure the battery quality. Otherwise, damage may occur.
- DO NOT charge other battery types with the supplied charger. Confirm there is no flammable material within 2 m of the charger during charging.
- DO NOT place the battery near heating or fire source. Avoid direct sunlight.
- DO NOT swallow the battery to avoid chemical burns.
- DO NOT place the battery in the reach of children.
- The lithium battery voltage is 3.6 V, and the battery capacity is 6230 mAh.
- The battery is certified by UL2054.

### Maintenance

- If the product does not work properly, please contact your dealer or the nearest service center. We shall not assume any responsibility for problems caused by unauthorized repair or maintenance.
- A few device components (e.g., electrolytic capacitor) require regular replacement. The average lifespan varies, so periodic checking is recommended. Contact your dealer for details.
- Wipe the device gently with a clean cloth and a small quantity of ethanol, if necessary.
- If the equipment is used in a manner not specified by the manufacturer, the protection provided by the device may be impaired.
- We recommend you send the device back for calibration once a year, and please contact the local dealer for the information on maintenance points.
- Please notice that the current limit of USB 3.0 PowerShare port may vary with the PC brand, which is likely to result in incompatibility issue. Therefore it's advised to use regular USB 3.0 or USB 2.0 port if the USB device

fails to be recognized by PC via USB 3.0 PowerShare port.

### Using Environment

- Make sure the running environment meets the requirement of the device. The operating temperature shall be -20 °C to 50 °C (-4 °F to 122 °F), and the operating humidity shall be 95% or less.
- DO NOT expose the device to high electromagnetic radiation or dusty environments.
- DO NOT aim the lens at the sun or any other bright light.

### Technical Support

The <https://www.hikmicrotech.com/en/contact-us.html> portal will help you as a HIKMICRO customer to get the most out of your HIKMICRO products. The portal gives you access to our support team, software and documentation, service contacts, etc.

### Emergency

- If smoke, odor, or noise arises from the device, immediately turn off the power, unplug the power cable, and contact the service center.

### Manufacture Address

Room 313, Unit B, Building 2, 399 Danfeng Road, Xixing Subdistrict, Binjiang District, Hangzhou, Zhejiang 310052, China

Hangzhou Microimage Software Co., Ltd

COMPLIANCE NOTICE: The thermal series products might be subject to export controls in various countries or regions, including without limitation, the United States, European Union, United Kingdom and/or other member countries of the Wassenaar Arrangement. Please consult your professional legal or compliance expert or local government authorities for any necessary export license requirements if you intend to transfer, export, re-export the thermal series products between different countries.



# Contents

<b>Chapter 1 Overview.....</b>	<b>1</b>
<b>1.1 Device Description.....</b>	<b>1</b>
<b>1.2 Main Function.....</b>	<b>1</b>
<b>1.3 Appearance.....</b>	<b>2</b>
<b>Chapter 2 Preparation .....</b>	<b>6</b>
<b>2.1 Mount Hand Strap .....</b>	<b>6</b>
<b>2.2 Operation Method .....</b>	<b>7</b>
<b>2.3 Charge Device .....</b>	<b>8</b>
<b>2.3.1 Charge Device via Cable Interface .....</b>	<b>8</b>
<b>2.3.2 Charge Device via Charging Base .....</b>	<b>9</b>
<b>2.4 Power On/Off .....</b>	<b>10</b>
<b>2.4.1 Set Auto Power-off Countdown .....</b>	<b>10</b>
<b>2.5 Menu Description .....</b>	<b>10</b>
<b>Chapter 3 Display Settings .....</b>	<b>12</b>
<b>3.1 Set Screen Brightness .....</b>	<b>12</b>
<b>3.2 Set Palettes .....</b>	<b>12</b>
<b>3.3 Set Opacity.....</b>	<b>12</b>
<b>3.4 Adjust Digital Zoom .....</b>	<b>13</b>
<b>3.5 Display OSD Info.....</b>	<b>13</b>
<b>Chapter 4 Acoustic Wave Detection.....</b>	<b>14</b>
<b>4.1 Set Detection Mode .....</b>	<b>14</b>
<b>4.2 Set Frequency Range .....</b>	<b>14</b>
<b>4.2.1 Set Overall Frequency Range .....</b>	<b>14</b>
<b>4.2.2 Set Max. Frequency .....</b>	<b>15</b>
<b>4.2.3 Set Min. Frequency .....</b>	<b>15</b>
<b>4.3 Set Sound Intensity Rule .....</b>	<b>16</b>
<b>Chapter 5 Picture and Video .....</b>	<b>17</b>
<b>5.1 Initialize Memory Card .....</b>	<b>17</b>
<b>5.2 Capture Picture.....</b>	<b>17</b>

5.3 Record Video .....	18
5.4 View Local Files.....	18
5.4.1 Manage Albums.....	19
5.4.2 Manage Files.....	20
5.5 Export Files .....	20
<b>Chapter 6 Connect.....</b>	<b>22</b>
6.1 Connect via Wi-Fi.....	22
6.2 Connect via Hotspot .....	22
<b>Chapter 7 Maintenance .....</b>	<b>24</b>
7.1 View Device Information .....	24
7.2 Set Date and Time .....	24
7.3 Upgrade Device .....	24
7.4 Restore Device.....	25

## Chapter 1 Overview

### 1.1 Device Description

The HIKMIRCO AI56 acoustic imaging camera is a professional product for sound source localization. With 64 Low-noise MEMS microphones and adjustable bandwidth range from 2 kHz to 60 kHz, AI56 provides an easy and effective way to locate the pressurized air leaks in industrial environments or detecting partial discharge in high-voltage systems. By using a large 4.3" LCD touch screen, the results presented on top of a digital picture allows you to quickly find the source of the problems. The maximum operating distance could reach 100 meters, which can ensure you stay at a safe distance to inspect the high-voltage equipment. Adopting this lightweight and easy-to-use tool, you can discover the potential safety risks, minimize troubleshooting, and save extra costs of equipment failures and downtime.

### 1.2 Main Function

#### Acoustic Imaging

Device detects the real-time sound intensity of the sources, and locates the sources in the scene.

#### Connection

Device can be connected to the client software via Wi-Fi and hotspot.

#### Palette

Device supports multiple palettes.

#### Record Videos & Capture Snapshots

Device supports recording videos, capturing snapshots, and managing albums.

### 1.3 Appearance

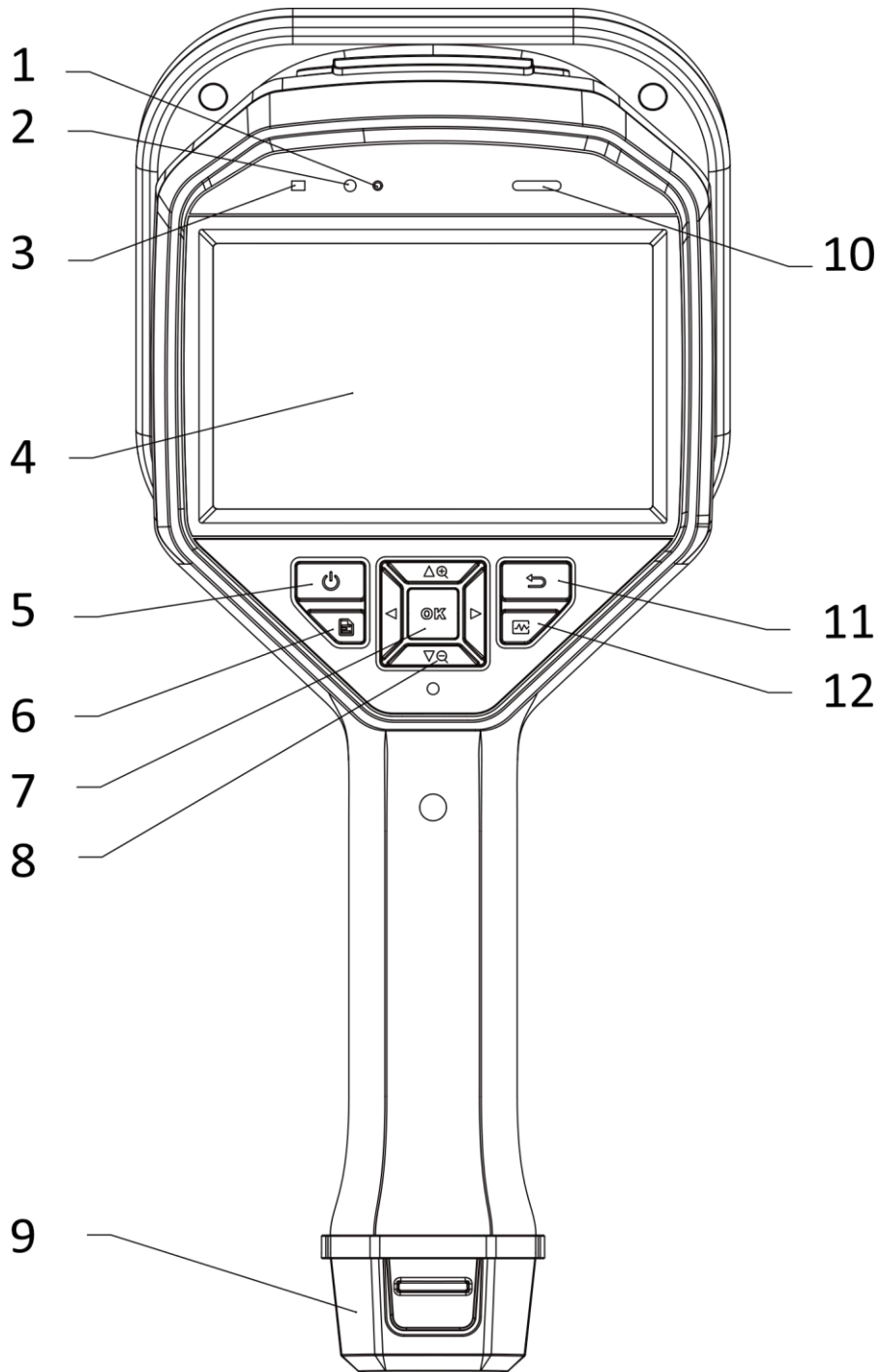

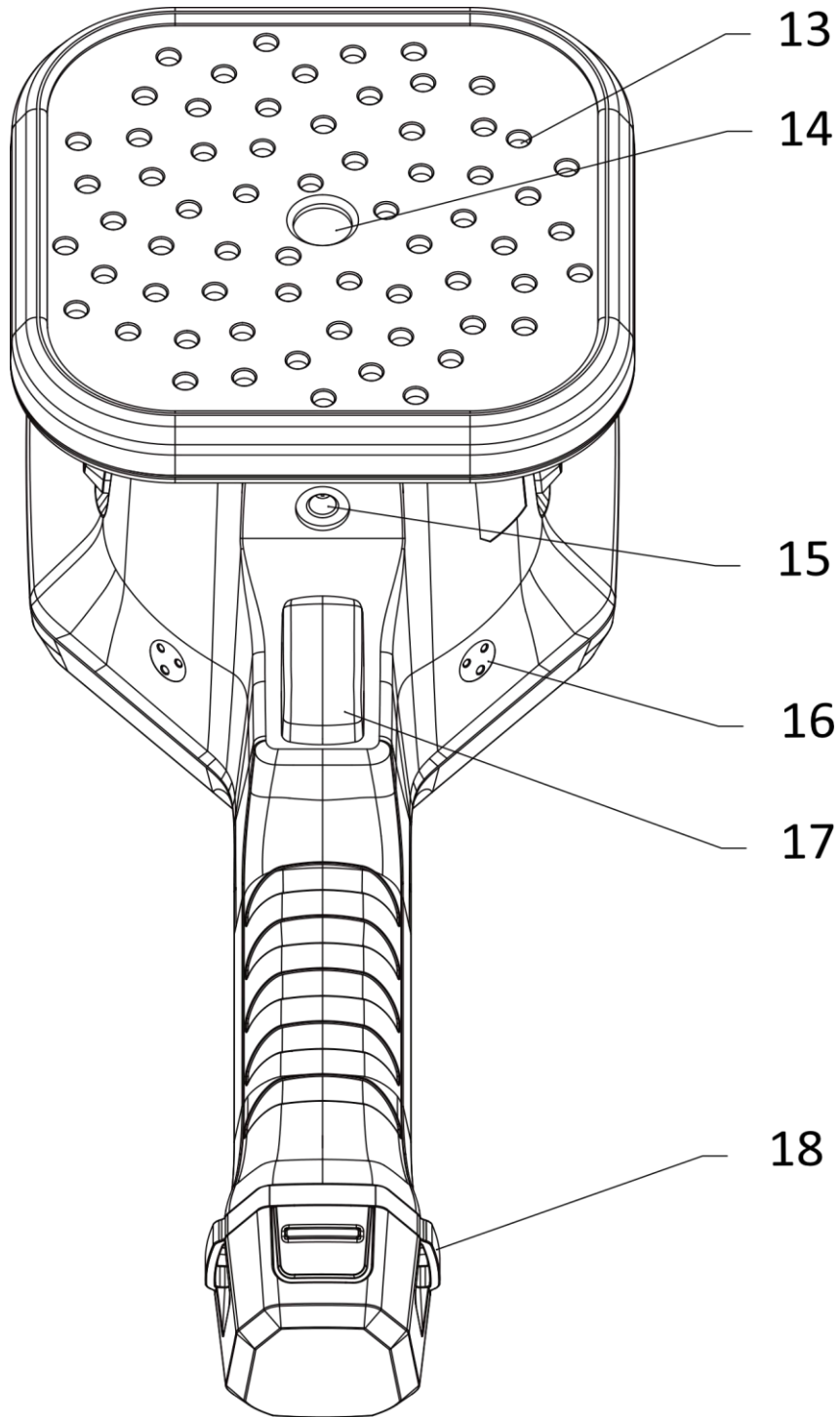

Figure 1-1 Appearance

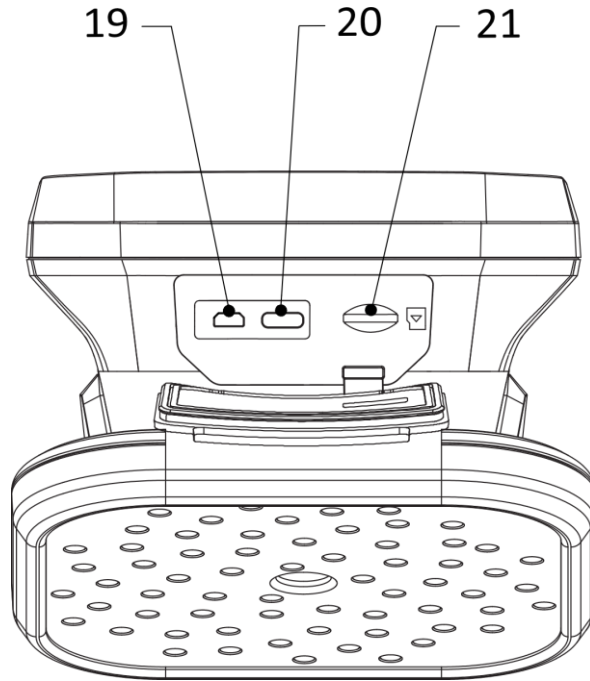





Figure 1-2 USB Interface

Table 1-1 Interface Description

No.	Component	Function
1	Light Sensor	Senses the ambient brightness.
2	Microphone	Records voice remarks.
3	Power Indicator	Solid red: Charge normally Solid green: Fully charged
4	LCD Touch Screen	Allows live view and touch-screen operation.
5	Power Button	Hold  to power on/off.
6	File Button	Press  to access the albums.
7	Confirm Button	Non-Menu Mode: Press  to enter menu. Menu Mode: Press  to confirm.

## Handheld Acoustic Imaging Camera User Manual

No.	Component	Function
8	Navigation Button	<p>Non-Menu Mode:</p> <ul style="list-style-type: none"> <li>● Press <math>\triangle\oplus</math> or <math>\nabla\ominus</math> to zoom in or zoom out by 0.1× continuously.</li> <li>● Hold <math>\triangle\oplus</math> or <math>\nabla\ominus</math> to zoom in or zoom out by 1× continuously.</li> </ul> <p>Menu Mode:</p> <p>Press <math>\triangle\oplus</math>, <math>\nabla\ominus</math>, <math>\triangleleft</math>, and <math>\triangleright</math> to select parameters.</p>
9	Battery Compartment	For holding the battery.
10	Loudspeaker	Plays voice remarks.
11	Back Button	Press $\curvearrowright$ to save the parameters and return to previous menu.
12	Frequency Button	Press to select the frequency range frame edges and configure the frequency parameters.
13	Microphone Array	Detects sound in the scene.
14	Optical Lens	Views the optical images.
15	Tripod Attachment Point	Mounts the tripod.
16	Hand Strap Attachment Points	Mounts the hand strap.
17	Trigger	<p>Non-Menu Mode:</p> <ul style="list-style-type: none"> <li>● Press: Capture snapshots.</li> <li>● Hold: Record videos.</li> </ul> <p>Menu Mode: Press to return to live view interface.</p>
18	Hand Strap Attachment Holes	Fixes the lower part of the hand strap to the device.
19	Micro HDMI Interface	Displays the image and menu interface via HDMI output.
20	Type-C Interface	Charges the device or exports files with supplied cable.
21	MicroSD Card Slot	For holding the MicroSD card.

## Chapter 2 Preparation

### 2.1 Mount Hand Strap

The hand straps aim at attaching to the device and stabilizing it. Please make sure wrap your hands with the hand straps to prevent the device from accidental falling or bumping.

The upper part of the hand strap is attached to the camera by a buckle. There are two buckle attachment points on both sides of the device. The lower part of the hand strap is threaded through the holes at the base of the device.

#### Steps

1. Insert the upper part of the hand straps into the buckles.

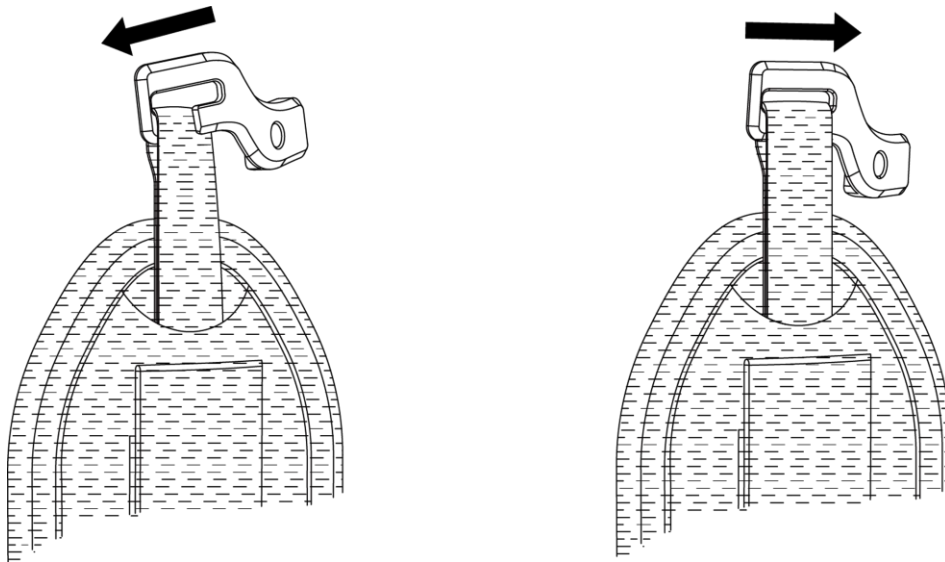

**Figure 2-1 Insert Upper Part of Hand Strap**

2. Fit the buckle on the device and tighten the screw with the supplied wrench.
3. Thread the lower part of the hand strap through the hole at the base of the device.
4. Secure the hand strap with the hook-and-loop fastener. Adjust the tightness according to your hands.



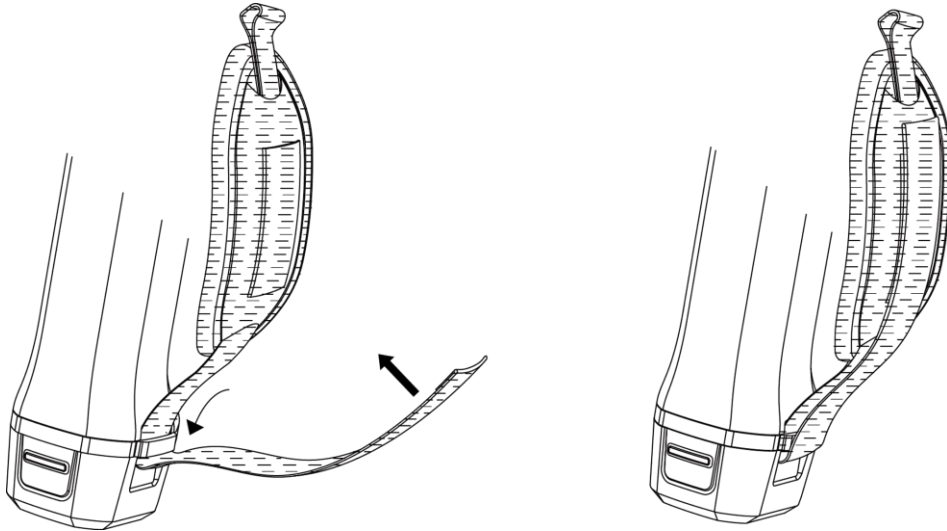

Figure 2-2 Secure Lower Part of Hand Strap

## 2.2 Operation Method

The device supports both touch-screen control and button control.

### Touch-Screen Control

Tap on the screen to set parameters and configurations.

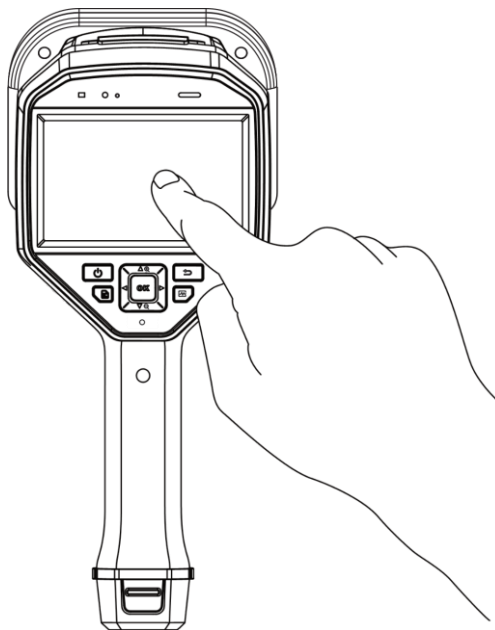
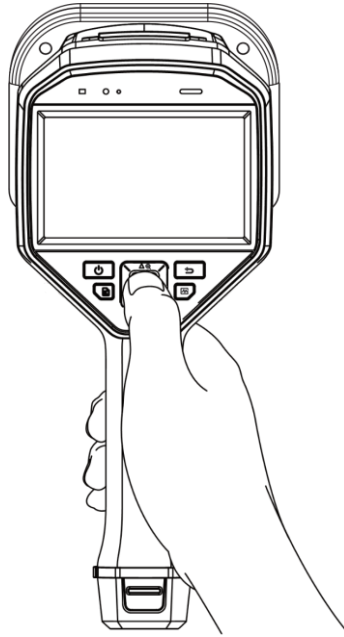

Figure 2-3 Touch-Screen Control

### Button Control

Press the navigation buttons to set parameters and configurations.



**Figure 2-4 Button Control**

## 2.3 Charge Device

Please fully charge the device before it is used for the first time or when it is in low battery.

### 2.3.1 Charge Device via Cable Interface

#### Before You Start

Please make sure the battery is installed before charging via cables.

#### Steps

1. Open the connector cover of the device.
2. Connect the type-C interface and the power adaptor with type-C or USB cable.

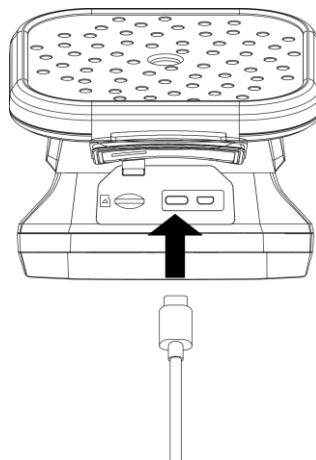

**Figure 2-5 Charge via Type-C Cable**

## 2.3.2 Charge Device via Charging Base

You can take out the battery and insert it into the charging base for fast charging.

### Before You Start

Please make sure the device is power off before removing the battery.

### Steps

1. Hold the device, and press both battery lock catches of the device.

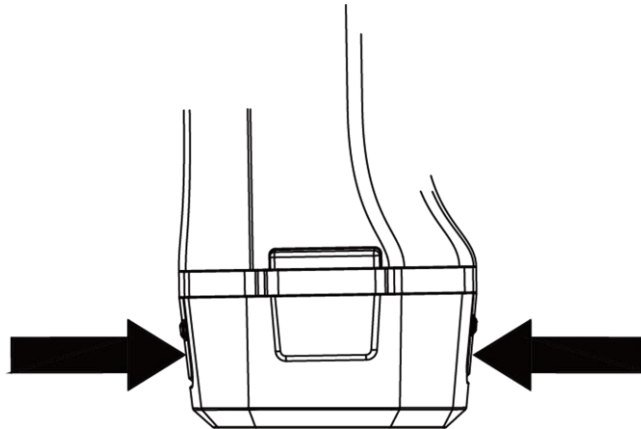

**Figure 2-6 Remove Battery Base**

2. Hold the lock catches, and draw the battery base to take out the battery.
3. Insert the battery into the charging base. You can see the charging status via the pilot lamp on the charging base.

---

### Note

The red indicating light is on if the battery is charging properly, and the green indicating light is on if the battery is fully charged.

---

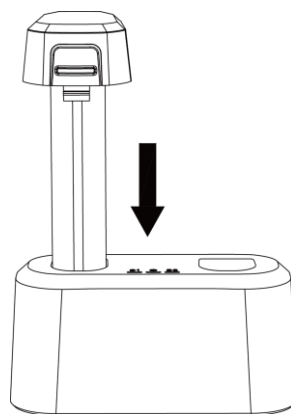

**Figure 2-7 Charge Battery**

4. When the battery is fully charged, draw the battery from the charging base.
5. Insert the battery into the device and push it into the locked position.

## 2.4 Power On/Off

### Power On

Hold  to turn on the device. You can observe the target when the live view interface is stable.

### Note



If the battery of the device is low, please charge it in time or replace it with a fully-charged standard battery, so as to ensure that the device functions normally.

### Power Off



When the device is turned on, hold  to power off the device.

### 2.4.1 Set Auto Power-off Countdown

#### Steps

1. Press  in the live view interface to show the menu.
2. Go to **Settings** → **Device Settings** → **Auto Off**.
3. Tap **Auto Off** or press  to enable auto power-off.
5. Set the automatic shutdown time for device as required.
4. Press  to save and return to previous menu.

## 2.5 Menu Description

In the live view interface, tap  or press  to show the menu bar, and swipe down to call the drop-down menu.

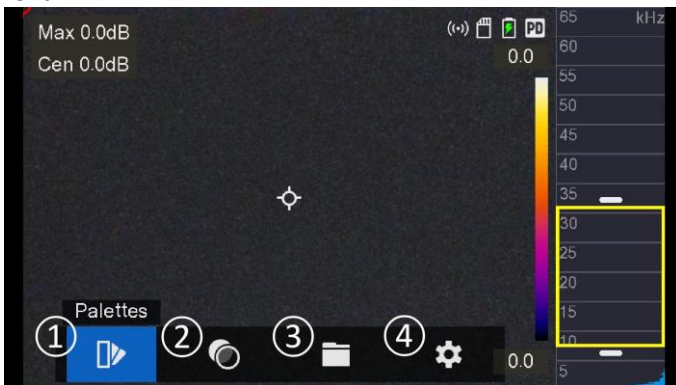

- ① Palettes
- ② Opacity
- ③ File
- ④ Settings

Figure 2-8 Main Menu

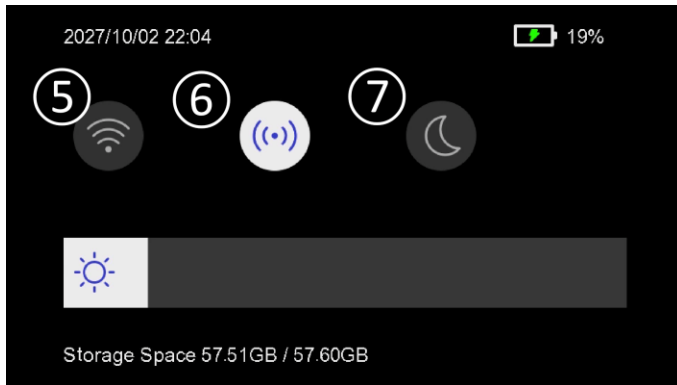

- ⑤ Wi-Fi
- ⑥ Hotspot
- ⑦ Dark/Bright Mode

**Figure 2-9 Drop-Down Menu**

## Chapter 3 Display Settings

### 3.1 Set Screen Brightness

You can manually adjust the screen brightness or enable automatic brightness adjustment to fine-tune the brightness levels for the screen.

#### Steps



1. In the live view interface, tap  or press  to show the menu.
2. Go to **Settings** → **Device Settings** → **Display Brightness**.
  - Auto: The device adjusts screen brightness automatically according to the ambient brightness.
  - Manually: Drag the brightness adjustment slider to the left or right to manually adjust screen brightness.





Figure 3-1 Brightness Adjustment Slider

### 3.2 Set Palettes

The device can collect sound data, and overlay the corresponding acoustic images on the optical images to mark the sound sources, and display sound intensities. You can switch preferable palettes for acoustic images.





#### Steps

1. Press  in the live view interface to show the menu.
2. Select  from the main menu, and tap on the icons to select a palette type.
3. Press  to save and exit.

### 3.3 Set Opacity

You can adjust the opacity of the acoustic images, and view the acoustic images and the optical images at the same time if the opacity is properly set.

#### Steps

1. In the live view interface, tap  or press  to show the menu.
2. Select , and choose the preferable opacity.
3. Press  to save and exit.

## Note

The opacity ranges from 0% to 100%. The lower the value is, the more transparent the acoustic images are.

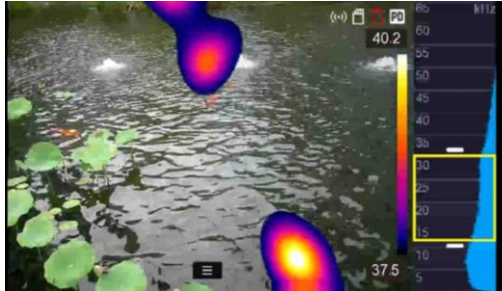

Figure 3-2 100% Opacity

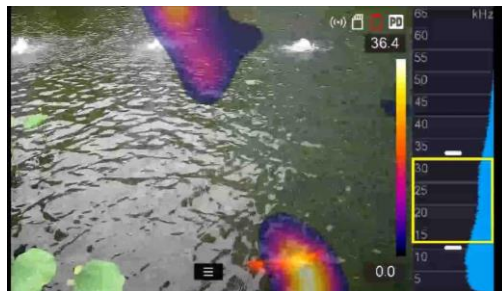

Figure 3-3 50% Opacity

---

## 3.4 Adjust Digital Zoom



The device supports 1× to 8× digital zoom.

- In the live view interface, hold  $\Delta\oplus$  or  $\nabla\ominus$  to zoom in or zoom out by 1× continuously.
- In the live view interface, press  $\Delta\oplus$  or  $\nabla\ominus$  to zoom in or zoom out by 0.1× precisely.

## 3.5 Display OSD Info.

OSD information informs you the status, time and date, and other information of the device in the live view interface.

### Steps

1. In the live view interface, tap  or press  $\textcircled{K}$  to show the menu.
2. Go to **Settings** → **Device Settings** → **Display Settings**.
3. Tap  or press  $\textcircled{K}$  to select the on-screen information.
4. Press  to save and exit.





## Chapter 4 Acoustic Wave Detection

The device supports acoustic wave detection. You can locate and mark the sound sources with acoustic images, and view the real-time sound intensities in the scene.

### 4.1 Set Detection Mode

The device supports compressed air leaks detection and partial discharge detection. You can set a proper detection mode catering to your needs.

#### Steps

1. In the live view interface, tap  or press  to show the menu.
2. Go to **Settings** → **Acoustic Settings** → **Detection Mode**.
3. Tap  or press  to select a detection mode.
4. Press  to save and exit.

### 4.2 Set Frequency Range





The device supports frequency range adjustment. You can set preferable frequency range to filter out background noises, so as to obtain the signals from the target frequency range.



Figure 4-1 Frequency Range

#### 4.2.1 Set Overall Frequency Range

##### Steps

1. Press  for once or tap the frequency range frame in the live view interface.
2. Press/hold  and , or drag the frequency range frame up and down to adjust the overall frequency range.
3. Press  to save and exit.



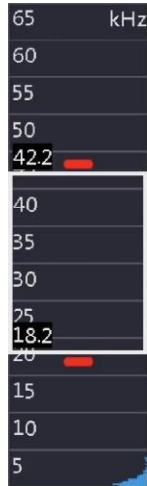

Figure 4-2 Set Overall Frequency Range

## 4.2.2 Set Max. Frequency

### Steps



1. Press  for 2 consecutive times or tap the top edge of the frequency range frame in the live view interface.
2. Press/hold  $\Delta \oplus$  and  $\nabla \ominus$ , or drag the top edge of the frequency range frame up and down to adjust the maximum frequency.
3. Press  to save and exit.



Figure 4-3 Set Max. Frequency

## 4.2.3 Set Min. Frequency

### Steps

1. Press  for 3 consecutive times or tap the bottom edge of the frequency range frame in the live view interface.

2. Press/hold  $\Delta \oplus$  and  $\nabla \ominus$ , or drag the bottom edge of the frequency range frame up and down to adjust the minimum frequency.
3. Press  $\hookrightarrow$  to save and exit.



Figure 4-4 Set Min. Frequency

**Note**

The frequency range is from 2 kHz to 60 kHz. The difference between max. and min. frequency ranges from 1 kHz to 24 kHz.

### 4.3 Set Sound Intensity Rule

You can monitor the real-time sound intensities of the target or the surroundings, and mark them with cursor. The corresponding results are displayed on the left of the interface.

**Steps**

1. In the live view interface, tap  $\equiv$  or press  $\textcircled{K}$  to show the menu.
2. Go to **Settings**  $\rightarrow$  **Acoustic Settings**  $\rightarrow$  **Sound Intensity Display**.
3. Set the point rules, and tap the icons or press  $\textcircled{K}$ .
4. Press  $\hookrightarrow$  to save and exit.

Table 4-1 Icon Description

Icon	Description
	Peak Point: locate the peak sound intensity in the scene
	Center Point: display the sound intensity of the center in the scene

## Chapter 5 Picture and Video

In the live view interface, you can record videos or capture snapshots to save important data. You can also export the recorded videos and snapshots to PC via USB cable.



### Note

- Capturing or recording is not allowed in menu mode.
  - When the device has no memory cards or it is connected to your PC, capturing, recording, and accessing to the albums are not allowed.
- 

### 5.1 Initialize Memory Card

You can initialize the memory card if needed.

#### Steps

1. Go to **Settings** → **Device Settings** → **Device Initialization**.
2. Select **SD Card Initialization**, and tap **OK** to initialize the memory card.

### 5.2 Capture Picture

You can capture snapshots of the target, and the snapshots will be automatically saved in the memory card. The capture modes are selectable.

#### Before You Start

The memory card must be inserted for picture storage.

#### Steps

1. Go to **Settings** → **Capture Settings**.
2. Select **Capture Mode** to set the capture mode.

**Single Capture**                      Capture one picture for one time by pulling the trigger for once.

**Timed Capture**                      Device captures one picture after the specified time interval. You can set the time interval as needed.

**Continuous Capture**              Capture multiple pictures for one time by pulling the trigger for once. You can set the amount of pictures.

3. **Optional:** After capturing, you can tap the thumbnail of the captured image at the right part of the interface to view and edit the image.
4. Select **Filename Header** to set filename header. The snapshot name consists of the header and the capture date and time.
4. Press  to save and exit.
5. In the live view interface, pull the trigger to capture snapshot.
6. Refer to **Export Files** to export the snapshots.

## 5.3 Record Video

You can record the target. The recorded video and the synchronous audio are saved in the memory card.

### Steps

1. In the live view interface, hold the trigger to start recording. The recording status icon and time icon appear.

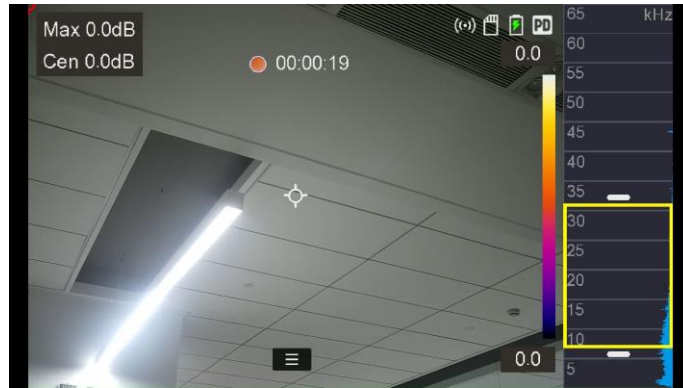



Figure 5-1 Record Video

2. When you finish, pull the trigger again to stop recording. The recorded video will be saved automatically and exit.

---

### Note

You can also press  or  to stop recording.

---

3. Refer to **Export Files** to export the snapshots.

---









### Note

The video format is MP4 format. You can play videos on the device or export to the compatible players to play.

---

## 5.4 View Local Files

### Steps

1. In the live view interface, press  to enter **Albums**.
2. Press  and  to select an album.
3. Press , , , and  to select a video clip or snapshot.
4. Press  to view the file.

**Table 5-1 File Type and Description**

File Type	Description
MP4 videos, format .mp4	Videos of this format can be played on local device, or exported to be played by any other supported player.
Radiometric images, format .jpeg	Images can be viewed on local device.

 **Note**













- Files are arranged in chronological order, with the most recent at the top. If you fails to find the most recently taken snapshots or videos, please check the time and date settings of your device. See **Set Date and Time** for instructions.
- For file exporting, see **Export Files** for instructions.

### What to do next

For file management, see **Manage Files** for instructions; for album management, see **Manage Albums** for instructions.













### 5.4.1 Manage Albums

The recorded image/video files are saved in the albums. You can create new albums, rename an album, change the default album, and delete albums.



Task	Operations
Create a New Album	<ol style="list-style-type: none"> <li>Press  to enter <b>Albums</b>.</li> <li>Tap .</li> <li>Enter an album name by the soft keyboard.</li> <li>Tap  to finish.</li> </ol>
Rename an Album	<ol style="list-style-type: none"> <li>Press  to enter <b>Albums</b>.</li> <li>Select the album to rename.</li> <li>Tap , and select <b>Rename</b>. A soft keyboard is displayed.</li> <li>Tap  to delete the old name, and enter the new name for the album by touching the screen.</li> <li>Tap  to finish.</li> </ol>
Change the Default Saving Album	<ol style="list-style-type: none"> <li>Press  to enter <b>Albums</b>.</li> <li>Select the album you want to use as the default saving album.</li> <li>Tap , and select <b>Set as Default Saving Album</b>.</li> </ol> <p> <b>Note</b> The default saving album appears at the top of the album list.</p>
Delete an Album	<ol style="list-style-type: none"> <li>Press  to enter <b>Albums</b>.</li> <li>Select the album you want to delete.</li> <li>Tap , and select <b>Delete</b>. A prompt box appears on the interface.</li> <li>Tap <b>OK</b> to delete the album.</li> </ol>

## 5.4.2 Manage Files

You can delete the recorded files and move the files to other albums on the device.

Task	Operations
Delete File(s)	<ol style="list-style-type: none"> <li>Press  to enter Albums.</li> <li>Tap to select the album storing the file to be deleted.</li> <li>In the album, tap to select the file to be deleted.</li> <li>Tap , and select <b>Delete</b>. A prompt box appears on the interface.</li> <li>Tap <b>OK</b> to delete the file.</li> </ol>
Move File(s)	<ol style="list-style-type: none"> <li>Press  to enter Albums.</li> <li>Tap to select the album storing the file to be moved.</li> <li>In the album, tap to select the file to be moved.</li> <li>Tap , and select <b>Move</b>. The album list is displayed.</li> <li>Tap to select the album to move to.</li> </ol>
Edit File(s)	<ol style="list-style-type: none"> <li>Press  to enter Albums.</li> <li>Tap to select the album storing the file to be edited.</li> <li>In the album, tap the file to be edited.</li> <li>Tap the video or snapshot file to start edit. <ul style="list-style-type: none"> <li>Tap  to add a text note to the file. You can tap the file to view the added text note.</li> <li>Tap  to add a voice note to the file. Tap  in the screen center to start or end recording the voice note.</li> <li>Tap  to play recorded videos.</li> <li>Tap  to move the file to other albums.</li> <li>Tap  to delete the file.</li> </ul> </li> </ol> <p> <b>Note</b> The text and voice notes can only be added to snapshots.</p>

### Note

You can tap  to select all files, and tap  to cancel the selection.

## 5.5 Export Files

Connecting the device to your PC with USB cable, you can export the recorded videos and captured snapshots.

### Note

- You can export the files using USB cable while the device is turned off.
- You can export the files by inserting the memory card to your PC which has a card slot.

### Steps

1. Open the cover of cable interface.
  2. Connect the device to your PC with cable and open the detected disk.
  3. Select and copy the videos or snapshots to PC to view the files.
  4. Disconnect the device from your PC.
- 

### Note



You can play the recorded videos using the default players.

---

## Chapter 6 Connect

### 6.1 Connect via Wi-Fi

#### Steps

1. Press  in the live view interface to show the menu.
2. Go to **Settings** → **Connect** → **WLAN**.
3. Tap  or press  to enable or disable **Wi-Fi**. When **Wi-Fi** is enabled, the device can automatically search and display available Wi-Fi networks.
4. Select a Wi-Fi network and enter password.

---

#### Note

- DO NOT tap space, or the password may be incorrect.
  - Leaving the Wi-Fi setting interface does not interrupt the connection.
- 





#### Result

A Wi-Fi icon shows in the live view interface when the connection is completed.

### 6.2 Connect via Hotspot

When the device's hotspot is on, other equipment with Wi-Fi function can join the device for data transmission.

#### Steps

1. Press  in the live view interface to show the menu.
2. Go to **Settings** → **Connect** → **Hot Spot**.
3. Tap  or press  to enable or disable hotspot.  in the status bar indicates that the hotspot is on.

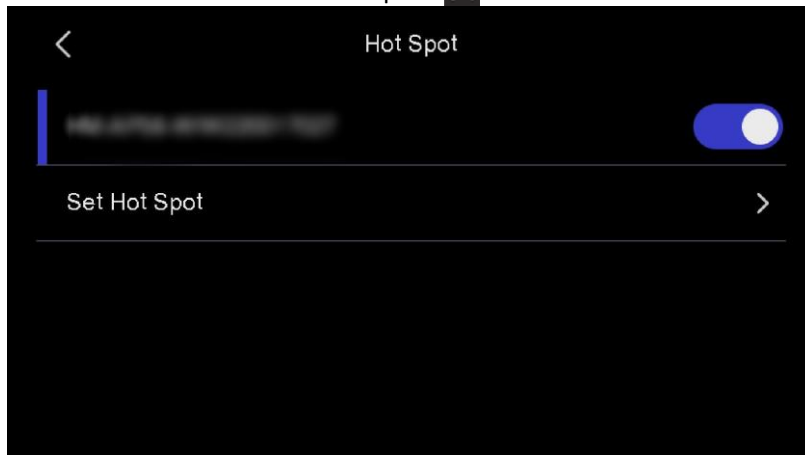

Figure 6-1 Hotspot



---

 **Note**

The hotspot name consists of the device model No. and series No.. Refer to ***View Device Information***.

---

4. Tap **Set Hot Spot** to set the hotspot password.
- 

 **Note**

When setting password, DO NOT tap **enter** or **space**, or the password may be incorrect. The password should include at least 8 digits, consisting of numbers and characters.



---

5. Tap  to save the password.

## Chapter 7 Maintenance

### 7.1 View Device Information



#### Steps

1. Press  to show the menu in the live view interface.
2. Go to **Settings** → **Device Information** to view the device information.
3. You can view the major information like device No., serial No., and the current version.
4. Press  to save and exit.

### 7.2 Set Date and Time

You can set and calibrate the system time and date.

#### Steps

1. Press  to show the menu in the live view interface.
2. Go to **Settings** → **Device Settings** → **Time and Date**.
3. Set the date and time.
4. Press  to save and exit.

#### Result

The time and date are displayed in the top area of the live view interface.



Go to **Settings** → **Image Settings** → **Display Settings** to enable or disable time and date display.

---

### 7.3 Upgrade Device

#### Before You Start

Please download the upgrade file and turn on the device.

#### Steps

1. Connect the device to your PC with cable and open the detected disk.
2. Copy the upgrade file and paste it to the root directory of the device.
3. Disconnect the device from your PC.
4. Reboot the device and then it will upgrade automatically. The upgrading process will be displayed in the main interface.



- Please make sure the battery is fully charged during when upgrading to avoid accidental suspension.
- After upgrading, the device reboots automatically. You can view the current version in **Settings** → **Device**

## Information.

---

## 7.4 Restore Device

You can default the device to the factory settings.

---



### Caution

This function should be used with caution.

---

### Steps

1. Press **OK** to show the menu in the live view interface.
2. Go to **Settings** → **Device Settings** → **Device Initialization**.
3. Select **Restore**. A prompt appears.

**OK:** Tap **OK** to initialize the device.

**Cancel:** Tap **Cancel** to exit and return to the previous menu.



**HIKMICRO**

See the World in a New Way

Facebook: HIKMICRO Thermography

Instagram: hikmicro\_thermography

E-mail: [support@hikmicrotech.com](mailto:support@hikmicrotech.com)

LinkedIn: HIKMICRO

YouTube: HIKMICRO Thermography

Website: <https://www.hikmicrotech.com/>