



# testo 300 / testo 300 LL - flue gas analyzer

Instruction manual



[www.testo.com/register](http://www.testo.com/register)  
**+ 1 year extra warranty  
for free**  
(more see page 2)





Register your Testo product at [www.testo.com/register](http://www.testo.com/register) and receive a one-year free warranty extension.

Product registration is permitted for up to 30 days after purchase.

For product registration terms and conditions and participating countries, please go to [www.testo.com/register](http://www.testo.com/register)



# Contents

<b>1</b>	<b>About this document .....</b>	<b>7</b>
1.1	Symbols .....	7
1.2	Warning notices .....	7
<b>2</b>	<b>Safety and disposal.....</b>	<b>8</b>
<b>3</b>	<b>Product-specific safety instructions .....</b>	<b>8</b>
<b>4</b>	<b>Authorisations and certification .....</b>	<b>8</b>
<b>5</b>	<b>Specifications .....</b>	<b>9</b>
<b>6</b>	<b>Product description .....</b>	<b>10</b>
6.1	Front view .....	10
6.2	Rear view .....	11
6.3	Connections .....	11
6.4	Compact flue gas probe.....	12
6.5	Modular flue gas probe .....	12
<b>7</b>	<b>First steps .....</b>	<b>13</b>
7.1	Commissioning .....	13
7.2	Mains unit / energy storage unit.....	13
7.2.1	Charge energy storage unit.....	13
7.2.2	Mains operation.....	14
7.3	Touchscreen operating concept.....	14
7.4	Keypad .....	15
7.5	Switch instrument on and off.....	15
7.6	Connect probes.....	17
<b>8</b>	<b>Using the product.....</b>	<b>18</b>
8.1	User interface .....	18
8.1.1	List reading display type.....	19
8.1.2	Graphics reading display type .....	20
8.1.3	Corestream reading display type.....	21
8.2	Overview of main menu (  ) .....	22
8.2.1	Customer / Measuring site .....	23
8.2.2	Protocols .....	26
8.2.3	Saved reports.....	27
8.2.4	Gas path check .....	29
8.2.5	Device settings .....	29
8.2.5.1	Country version and language.....	29
8.2.5.2	Wireless LAN .....	31
8.2.5.3	Date/Time.....	32
8.2.5.4	Own company address.....	34
8.2.5.5	Bluetooth.....	34

# Contents

---

8.2.5.6	Hotspot.....	35
8.2.5.7	Display brightness.....	35
8.2.5.8	CO/NO sensor protect.....	36
8.2.5.9	O <sub>2</sub> reference.....	36
8.2.5.10	Alarm limits.....	36
8.2.6	Sensor diagnosis.....	37
8.2.7	Error list.....	37
8.2.8	Device information.....	37
8.2.9	Server information.....	37
8.2.10	E-mail.....	38
8.2.11	My Apps.....	40
8.2.12	Help.....	40
8.2.12.1	Device registration.....	40
8.2.12.2	Tutorial.....	41
8.2.12.3	Setup Wizard.....	41
8.2.12.4	Update via USB.....	41
<b>9</b>	<b>Performing the measurement.....</b>	<b>42</b>
9.1	Prepare for measurement.....	42
9.2	Zeroing phases.....	42
9.3	Carry out gas path check.....	43
9.4	Use of flue gas probe.....	43
9.5	Overview of measurement types (  ).....	45
9.5.1	Flue gas.....	46
9.5.2	Draught.....	47
9.5.3	CO undiluted.....	48
9.5.4	Smoke number.....	48
9.5.5	Differential pressure.....	49
9.5.6	Differential temp.....	50
9.5.7	O <sub>2</sub> supply air.....	50
9.5.8	Gas flow.....	50
9.5.9	Oil flow rate.....	51
9.5.10	CO ambient.....	51
9.5.11	Tightness test 1.....	52
9.5.12	Tightness test 2.....	53
9.5.13	Let by test.....	55
9.5.14	4 Pa measurement.....	56

9.6	Overview of options (  ).....	60
9.6.1	Edit view.....	60
9.6.1	Zeroing Gas Sensors .....	63
9.6.2	Mean value calculation.....	63
9.7	Overview of protocols (  ).....	64
9.7.1	Print data.....	65
9.7.2	Save.....	66
9.7.3	Finish protocol.....	66
<b>10</b>	<b>Maintenance .....</b>	<b>68</b>
10.1	Service .....	68
10.2	Calibration.....	68
10.3	Check instrument status .....	68
10.3.1	Sensor diagnosis.....	68
10.3.2	Error list.....	68
10.4	Clean the measuring instrument.....	68
10.5	Drain condensate container.....	69
10.6	Open the measuring instrument.....	70
10.7	Replace sensors .....	72
10.7.1	Replace O2 sensor .....	73
10.7.2	Change CO, CO H2 and NO sensor .....	74
10.8	Clean modular flue gas probe.....	75
10.9	Replace the probe module.....	75
10.10	Check/replace particle filter.....	76
10.11	Replace thermocouple.....	77
<b>11</b>	<b>Technical data .....</b>	<b>78</b>
<b>12</b>	<b>Contact and support .....</b>	<b>79</b>



# 1 About this document

- The instruction manual is an integral part of the instrument.
- Keep this documentation to hand so that you can refer to it when necessary.
- Please read this instruction manual through carefully and familiarize yourself with the product before putting it to use.
- Hand this instruction manual on to any subsequent users of the product.
- Pay particular attention to the safety instructions and warning advice in order to prevent injury and damage to the product.

## 1.1 Symbols

Display	Explanation
	Note: basic or further information
1 2 ...	Action: several steps, the sequence must be followed.
▶	Result of an action
✓	Requirement

## 1.2 Warning notices

Always pay attention to any information marked with the following warning notices along with warning pictograms. Implement the specified precautionary measures!

 **DANGER**

Risk of death!

 **WARNING**

Indicates possible serious injury.

 **CAUTION**

Indicates possible minor injury.

**CAUTION**

Indicates possible damage to equipment.

## 2 Safety and disposal

Take the **testo information** document into account (accompanies the product).

## 3 Product-specific safety instructions

### CAUTION

**The condensate may be acidic.  
Risk of burns to the hands!**

- Wear acid-resistant safety gloves, glasses and overalls to empty the condensate.

---

- Make sure that the condensate has been fully emptied out of the condensate trap before the measuring instrument is stored for a long time.
- Before disposing of the product, the condensate trap must be emptied and the condensate in the crude gas tube disposed of in a suitable container.
- When testing a gas pipe, pay attention to the following:

### WARNING

Dangerous mixture of gases

**Danger of explosion!**

- Make sure there are no leaks between the sampling point and the measuring instrument.
  - Do not smoke or use naked flames during the measurement.
- 

## 4 Authorisations and certification

Please find the current country approvals in the **Approval and Certification** document which is enclosed with the product.



## 5 Specifications

The testo 300 is a measuring instrument which enables the professional flue gas analysis of combustion plants, such as

- small combustion plants (oil, gas, wood, coal)
- low-temperature and condensing boilers
- gas heaters.

Using the instrument, these systems can be adjusted and checked for compliance with the applicable limit values.

The instrument has been verified as a short-term measuring instrument and should not be used as a safety (alarm) device.

The following tasks can also be carried out using the instrument:

- Regulating the O<sub>2</sub>, CO and CO<sub>2</sub>, NO, NO<sub>x</sub> values in combustion plants to ensure optimum operation.
- Draught measurement.
- 4 Pa measurement
- Measuring and regulating the gas flow pressure in gas heaters.
- Measuring and optimising the flow and return temperatures of heating systems.
- Measuring the CO concentration in the ambient air.
- The instrument can be used for measurements on CHP plants in accordance with the first German Federal Immission Control Ordinance (BImSchV).
- In principle, the CO sensor can also be used for measurements on CHP plants. If you carry out more than 50 measurements on CHP plants per year, please contact your nearest Testo service centre or send the instrument to Testo Service for checking.

An NO<sub>x</sub> filter for the CO sensor can be ordered as a spare part to replace a used filter.

# 6 Product description

## 6.1 Front view



1	USB interface/ mains connection	4	User interface
2	Gas outlet	5	Condensate container
3	On/Off button	6	Connections

## 6.2 Rear view

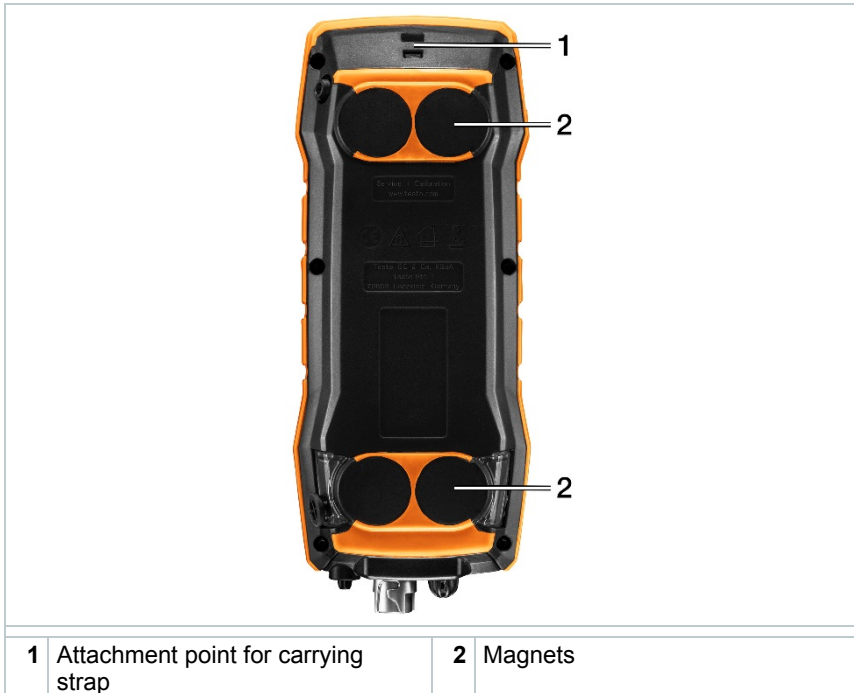

## 6.3 Connections

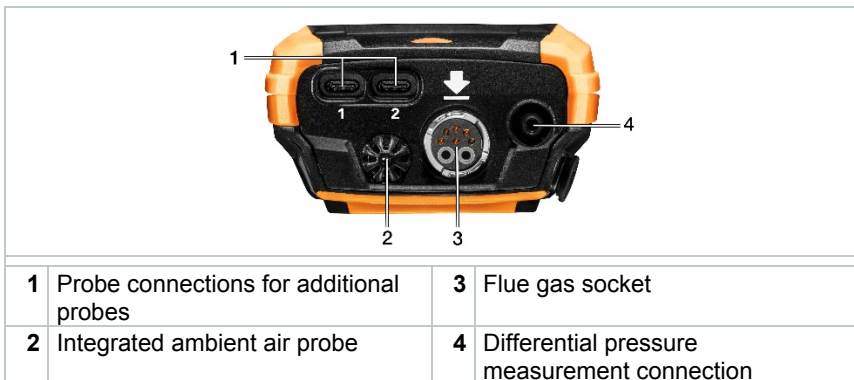



There must be no more than one extension lead (0554 1201) connected between flue gas socket and flue gas probe.

### 6.4 Compact flue gas probe



1	Removable filter chamber with window and particle filter	3	Connector plug for measuring instrument
2	Probe handle	4	Connection cable

### 6.5 Modular flue gas probe



1	Removable filter chamber with window and particle filter	4	Connector plug for measuring instrument
2	Lock release	5	Probe handle
3	Probe module	6	Connection cable

## 7 First steps

### 7.1 Commissioning

Take the information in the **testo information** document (included with the product) into account for this.

### 7.2 Mains unit / energy storage unit

The measuring instrument is supplied with an energy storage unit.



Fully charge the energy storage unit before using the measuring instrument.



If the mains unit is connected, the measuring instrument is automatically powered via the mains unit.



Only charge the energy storage unit at an ambient temperature of 0 to 35°C.



Storage conditions for the energy storage unit:

- Ambient temperature from 10 to 20°C
- Charge level of 50 to 80%

#### 7.2.1 Charge energy storage unit

- 1 Connect the instrument plug of the mains unit to the mains unit socket on the measuring instrument.
- 2 Connect the mains plug of the mains unit to a mains socket.

- ▶ The charging process starts. LED in the condensate trap flashes red.  
The charging process stops automatically when the energy storage unit is fully charged. LED in the condensate trap has a continuous red light.



If the energy storage unit has discharged completely, the charging time at room temperature is approx. 5-6 hrs.

## 7.2.2 Mains operation

- 1 Connect the instrument plug of the mains unit to the mains unit socket on the measuring instrument.
  - 2 Connect the mains plug of the mains unit to a mains socket.
- ▶ The measuring instrument is powered via the mains unit.
  - ▶ If the instrument is switched off and an energy storage unit is inserted, the charging process will start automatically. Switching the measuring instrument on stops the charging of the energy storage unit and the measuring instrument is powered via the mains unit.



For longer measurements involving mains operation, Testo recommends using a combustion air temperature probe with connection cable. Self-heating of the instrument during mains operation may influence the combustion air temperature measurement using a mini ambient air probe.

## 7.3 Touchscreen operating concept

Familiarize yourself with the touchscreen operating concept before you use the measuring instrument.

Actions are mostly carried out by:

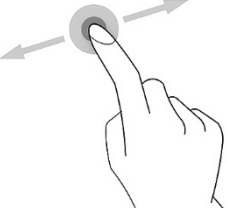
Description	
<p><b>Tapping</b></p> <p>To open applications, select menu symbols, press buttons on the display or enter characters with the keypad, in each case tap these with a finger.</p>	
<p><b>Swiping</b></p> <p>Swipe to the right or left on the display to show further views, e.g. to switch from the list view to the graphic view.</p>	

## Description

**Zooming**

In order to make a section of the display larger or smaller, touch the display with two fingers and move them apart or together.

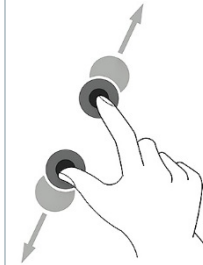
**Dragging**

You can move an element by touching it, holding it and dragging it to the required position.  
Example: Changing the display sequence of the measurement parameters.

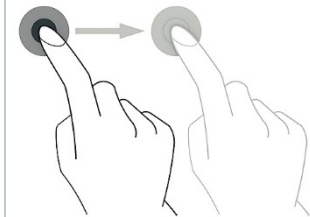

## 7.4 Keypad

Some functions require values (figures, numerical value, unit, characters) to be entered. The values are entered via a keypad.

✓ Input field is enabled (flashing cursor)

1 Enter value: tap the required value on the display (figures, numerical value, unit, characters).



2 Confirm entry: Press .

3 Repeat steps as required.

## 7.5 Switch instrument on and off

Current status	Action	Function
Instrument off	Press the button for a long time (> 3 s)	Instrument is switched on.

Current status	Action	Function
	<p>When the measuring instrument is started for the first time, the setup wizard guides you through the following setting parameters step by step:</p> <ul style="list-style-type: none"> <li>- <b>Country version</b></li> <li>- <b>Language</b></li> <li>- <b>Wireless LAN</b></li> <li>- <b>Date and Time</b></li> <li>- <b>Own company address</b></li> <li>- <b>E-mail account</b></li> </ul> <p>A tutorial can be started after the setup wizard. The tutorial demonstrates the general operation and the most important functions of the measuring instrument using examples.</p>	
Instrument on	Press the button briefly (< 1 s)	Instrument is switched to standby mode. The instrument is re-activated when the button is pressed again.
Instrument on	Press the button for a long time (> 1 s)	Selection: <b>[OK]</b> Instrument is switched off or cancel the instrument being switched off with <b>[Cancel]</b> .



Standby mode has 3 time-dependent functions:

- Standby time up to 1 min: Immediate restart after pressing the key.
- Standby time up to 1 hour: After pressing the key, a restart takes place after 5 seconds.
- Standby time more than 1 hour: testo 300 is in power save mode. After pressing the key, a restart takes place after the zeroing phase.



Unsaved readings are lost when the measuring instrument is switched off.



## 7.6 Connect probes

### Flue gas probes

- ✓ Instrument is switched on.
- 1 Insert the connector plug into the flue gas socket and lock it in place by turning it slightly clockwise (bayonet lock).



There must be no more than one extension line (0554 1201) between measuring instrument and flue gas probe.

### Temperature adapter

- ✓ Instrument is switched on.
- 1 Insert the connector plug of the probe into the probe socket.



- ▶ System recognizes the probe (info is displayed).



The parameter which is measured with an external probe is identified on the display by "ext.".

## 8 Using the product

### 8.1 User interface

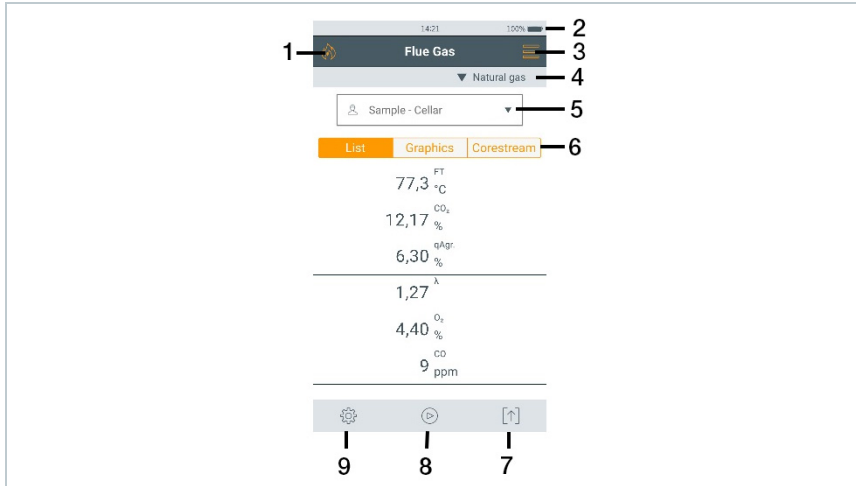

1		<b>Measurement types</b>
2		Status bar
3		<b>Main menu</b>
4		Open <b>Fuels</b> selection list
5		Select <b>Customer/Measuring site</b>
6		Select reading display type: <ul style="list-style-type: none"> <li>List</li> <li>Graphics</li> <li>Corestream</li> </ul>
7		Edit measurement data
8		Start measurement Pause measurement Stop measurement
9		<b>Options</b>

Further symbols on the user interface (without numbering)

	Retry measurement
	One level back

	One level back
	One level back
	Cancel process
	Print values
	Save report
	Save and send report

### 8.1.1 List reading display type

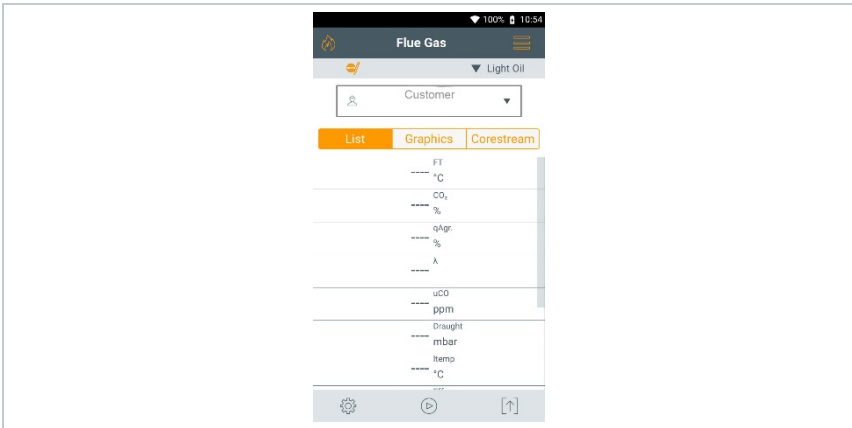

The measurement parameters/units and the number and order of the measurement parameters displayed in the **List** reading display type can be set, see Section **Edit View**.

Only those measurement parameters and units that are enabled in the reading display appear in the reading display, in the saved measurement protocols and on the report printouts.

The settings only apply to the measurement type currently enabled.

### 8.1.2 Graphics reading display type

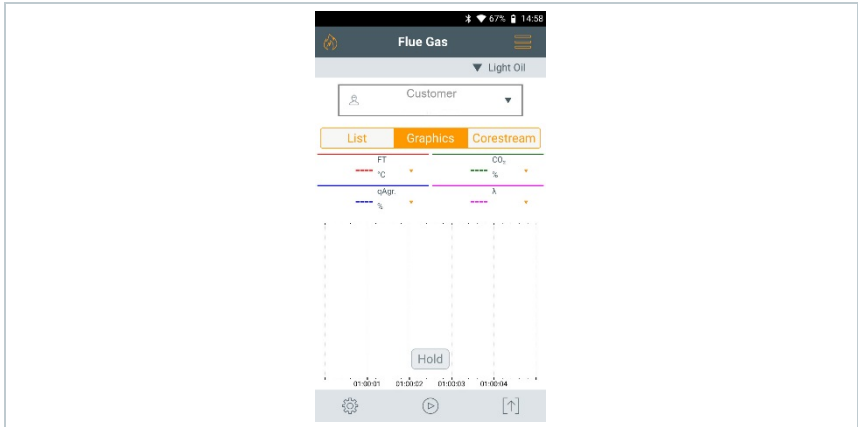

In the **Graphics** reading display type, the reading progression can be displayed as a line diagram.

A maximum of 4 measurement parameters can be set at any one time. Only those measurement parameters/units can be displayed that are available in the **List** reading display type.



The measurement parameters/units can be adjusted if necessary:

- ✓ Measurement view is enabled.
- 1 Call up function: **Graphics**
- 2 Tap on ▼ in order to open selection list for measurement parameters/units.
- 3 Select desired measurement data / units.
- ▶ Selection is accepted automatically.

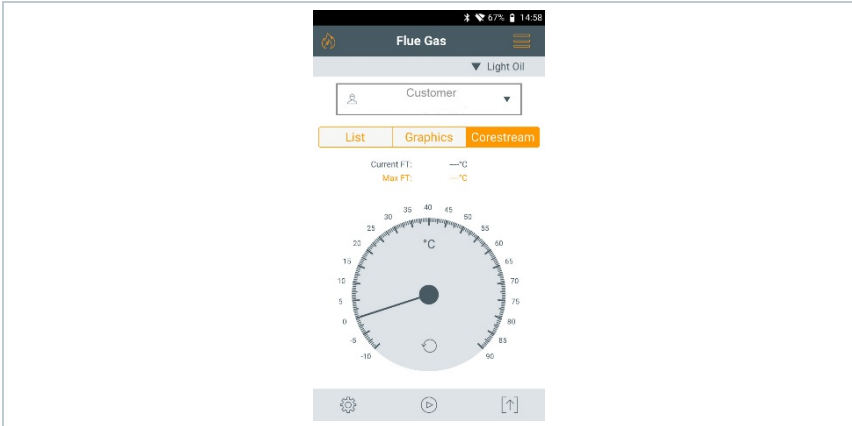
### 8.1.3 Corestream reading display type



Search for corestream:

- ✓ Measurement view is enabled.
- 1 Call up function: **Corestream**
- 2 Start search: 
- 3 Perform zeroing.
  - ▶ The measurement starts automatically after zeroing.
- 4 Align the flue gas probe in the flue gas duct so that the probe tip is in the corestream (area of the highest flue gas temperature **Max FT**).
  - Grey value/grey pointer: Display of current flue gas temperature
  - Orange value/orange pointer: Display of maximum flue gas temperature
  - Reset values/pointer: 

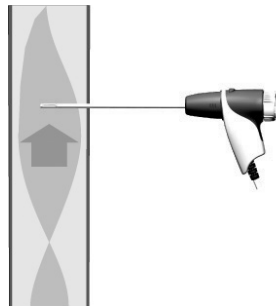

## 8.2 Overview of main menu (☰)

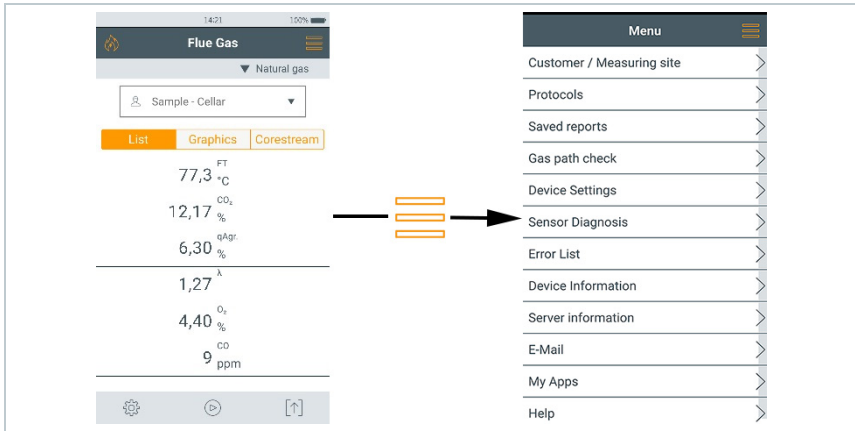

Main menu	Description
<b>Customer / Measuring site</b>	Create, edit and delete customer and system information.
<b>Protocols</b>	Call up, delete and send measurements that have been performed (various formats possible).
<b>Saved reports</b>	Call up and delete measurement report.
<b>Gas path check</b>	For flawless operation of the measuring instrument, regular tightness testing of measurement systems (measuring instrument + flue gas probe) is recommended.
<b>Device Settings</b>	Settings <ul style="list-style-type: none"> <li>- <b>Country version and language</b></li> <li>- <b>Wireless LAN</b></li> <li>- <b>Date &amp; Time</b></li> <li>- <b>Own company address</b></li> <li>- <b>Bluetooth®</b></li> <li>- <b>Hotspot</b></li> <li>- <b>Display brightness</b></li> <li>- <b>CO sensor protect</b></li> <li>- <b>NO2 addition</b></li> <li>- <b>O2 reference</b></li> <li>- <b>Alarm limits</b></li> </ul>
<b>Sensor Diagnosis</b>	Overview of the sensors fitted and their condition.
<b>Error List</b>	Call up error reports

Main menu	Description
<b>Device information</b>	Information <ul style="list-style-type: none"> <li>- Device name</li> <li>- Serial number</li> <li>- Device identification number</li> <li>- Last service</li> <li>- Free memory</li> <li>- Operating hours</li> <li>- Operating hours since last service</li> <li>- Software version</li> <li>- Firmware version</li> <li>- Firmware date</li> <li>- qA version</li> <li>- qA date</li> </ul>
<b>Server information</b>	Information about the available server
<b>E-Mail</b>	Set up e-mail account and the e-mail account can be called up.
<b>My Apps</b>	Additional applications <ul style="list-style-type: none"> <li>- Alarm clock</li> <li>- E-Mail</li> <li>- Gallery</li> <li>- Browser</li> <li>- Calendar</li> <li>- Pocket calculator</li> <li>- QuickSupport</li> <li>- File manager</li> </ul>
<b>Help</b>	Aids <ul style="list-style-type: none"> <li>- Device Registration</li> <li>- Tutorial</li> <li>- Setup Wizard</li> <li>- Help Online</li> <li>- Testo Website</li> <li>- Update via USB</li> </ul>

## 8.2.1 Customer / Measuring site

Create, edit and copy Customer / Measuring site information.

Customer / Measuring site can be deleted.

1 | Call up function:  | **Customer / Measuring site**

▶ | **Customer / Measuring site** menu is displayed.

The following functions are available:

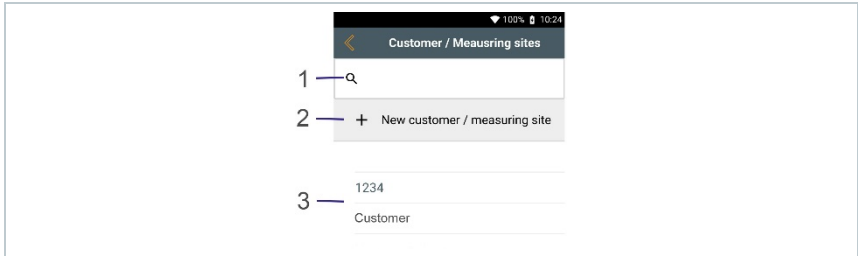

1	Search	3	View/edit existing data about Customer / Measuring site
2	Create new Customer / Measuring site		

### Search

- 1 Tap **Search** operating field.
  - ▶ Text cursor flashes.
- 2 Enter search test using the text editor.



Via the search text, only the Customer / Measuring site is displayed that contains characteristics of the search text.

- 3 Confirm search result: press .

### Create new customer

- 1 Tap **+ New Customer / Measuring site**.
  - ▶ **Customer** input screen is opened.
- 2 Tap the required input field.
  - ▶ Keypad appears.
- 3 Enter the information via the keypad.



- 
- 4 | Confirm each input with .



The **Customer/Company Name** input field is a required field and must be filled in.

- 
- 5 | **Save.**

- ▶ | Customer is created.



In order to be able to select a customer, at least one measuring site must be created and selected!

---

### Create new measuring site

- ✓ | A customer is created.

- 1 | Tap **Measuring site** button.

- 2 | Tap **+ New measuring site** operating field.

- ▶ | **Measuring site parameters** menu is opened.

- 3 | Enter data.



The **Name of measuring site** input field is a required field and must be filled in.

- 
- 4 | Confirm each input with .



An additional button (>) appears in some input fields.

These buttons contain a selection of parameters which are adopted in the input field by tapping on them.

- 
- 5 | **Save.**

### Edit customer

- 1 | Tap customer.



- ▶ | **Customer** input screen is opened.

- 2 | Input fields can be edited.

### Edit measuring site

- ✓ Customer input screen is open.
- 1 Tap **Measuring site** button.
- 2 Select **Measuring site**.
- 3 Edit data.
- 4 **Save**.

## 8.2.2 Protocols

- 1 Call up function:  | **Protocols**
- ▶ **Protocols** menu is displayed.
- 2 Select customer.
- 3 Open measuring site.
- 4 Measurements for the selected customer / measuring site can be viewed  and deleted .

More options for selected measurement :



Print readings



Save report



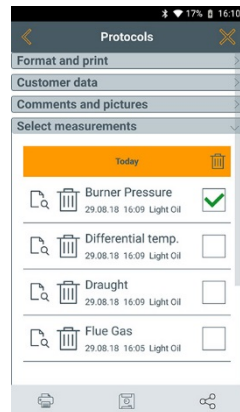

Save and send report



The following information can be selected / added to create a report.

Category	Description
<b>Format and print</b>	Select output format(s): <ul style="list-style-type: none"> <li>- <b>CSV</b> (comma separated text file, e.g. for Microsoft® Excel)</li> <li>- <b>PDF</b></li> <li>- <b>ZIV 2.00</b> (XML file, complying with the regulations of the Guild of Master Chimney Sweeps in Germany).</li> </ul>
<b>Customer data</b>	Enter / add contact details.
<b>Comments and pictures</b>	Enter comments and <b>Add</b> (opens the <b>Gallery</b> ). Pictures are only included when output is in PDF format.
<b>Select measurements</b>	All saved measurements are displayed in one of the following time categories, depending on the creation date: <b>Today</b> , <b>Yesterday</b> or <b>Older</b> . The measurements selected to create the report are identified with  .
<b>Signature</b>	Sign report.

- 5 | Back to the main menu: tap   
or  
Back to the measurement menu: tap .



If you have saved more than 100 measurements, they can be stored in the archive folder. A dialogue window appears automatically and you can choose whether you want to create this archive folder or not.

### 8.2.3 Saved reports

The measurement reports that have been created are stored under **Saved reports**. These can be called up again, sent or deleted.

- 1 | Call up function:  | **Saved reports**.
- ▶ | The **OI File Manager** folder is opened and the available reports are displayed.

#### Open report

- 1 | Tap required report.
- ▶ | Report is displayed as a PDF.

### Delete report(s)

1 Touch required report for >2 sec.

▶ Report is marked.

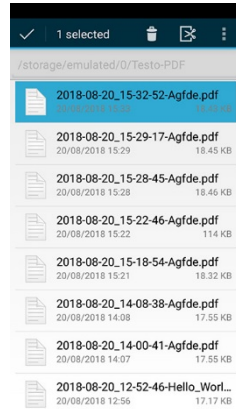

2 If necessary, mark more reports by tapping.

3 Delete report(s): tap .

### Send report(s)

1 Touch report for >2 sec.

▶ Report is marked.

2 If necessary, mark more reports by tapping

3 Tap  symbol.

4 Tap **Send**.



5 Send report by e-mail.

**Sort report(s)**

- 1 | Tap  symbol.
  - 2 | Tap **Settings**.
  - 3 | Disable **in ascending order** under sort settings.
- ▶ The latest reports are displayed first.

**8.2.4 Gas path check**

For flawless operation of the measuring instrument, regular tightness testing of measurement systems (measuring instrument + flue gas probe) is recommended.

- 1 | Call up function:  | **Gas path check**
- ▶ Gas path check starts automatically.
- 2 | Place the black sealing cap on the tip of the flue gas probe.
- ▶ The pump flow is displayed. If the flow rate is less than 0.02 l/min, the gas paths are not leaking and the measurement is ended.
- 3 | Remove the sealing cap from the probe tip.
  - 4 | Back to the main menu: tap .

**8.2.5 Device settings****8.2.5.1 Country version and language**

Set up your measuring instrument country-specifically.

The country version configuration affects the measurement parameters, fuels, fuel parameters and the bases of and formulas for calculations that are enabled. The country version configuration affects the user interface languages that can be enabled.

- 1 | Call up function:  | **Device Settings** | **Country version and language**

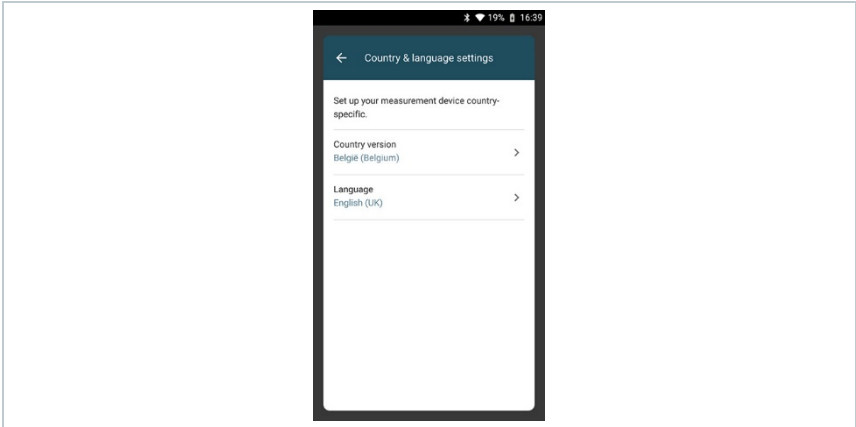

### Set country version

- 1 Tap **Country version** selection field.
  - ▶ The available country versions are displayed.
- 2 Select country version.
  - ▶ The query **Change country version?** is displayed.
- 3 Tap **Next**.



Configuration of the country version can be ended by cancelling. The display goes back to **Device Settings**.

---

- ▶ The selected country version is configured (this may take a few minutes). The **Device Settings** menu is then displayed.
- ▶ Restart the measuring instrument to complete its configuration.

### Set language

- ✓ | **Country & language settings** menu
- 1 Tap **Language** selection field.
    - ▶ The available languages for the selected country version are displayed.

- 2 | Select **Language** and tap ← .
- ▶ | The instrument is reconfigured to the selected language.
- 1 | Back to the main menu: tap ← and ↩ .

### 8.2.5.2 Wireless LAN



A radio link, such as a Wireless LAN, is not relevant for carrying out measurements.

Set up a connection to a Wireless LAN router or a Wireless LAN hotspot. The connection enables the sending of measurement reports on site by e-mail.

- 1 | Call up function: ☰ | **Device Settings** | **Wireless LAN**.
- 2 | Tap **Wireless LAN** selection field.
- 3 | Enable **Wireless LAN**: tap **Off** button or move grey point to the right.
  - ▶ | Instrument switches to **On**. The point changes to green.
  - ▶ | Display of all available **Wireless LAN** routers or **Wireless LAN** hotspots in the vicinity.
- 4 | Select **Wireless LAN** router or **Wireless LAN** hotspot.
- 5 | Tap **Connect**.
- 6 | It may be necessary to enter the password for the selected **Wireless LAN**.
  - ▶ | Connection is set up and shown by **Connected**.

**Further entries via  button**

Category	Description
<b>Add network</b>	Enter network name using the keypad, set security standard and if necessary enter further options. Save entry.
<b>Saved networks</b>	Display of saved networks.
<b>Updating</b>	Updating the display of available networks.
<b>Advanced</b>	Further Wireless LAN settings are displayed.



The Wireless LAN is disabled in standby mode and enabled again once you quit standby mode. The enabling process may take a few seconds.

**8.2.5.3 Date/Time**

You can set the date, time and time zone in the **Date/Time** menu. You can choose between the 24 hr or AM/PM formats for the time.



If the Wireless LAN has already been enabled, the Date/Time provided by the network is automatically set.

1 Call up function:  | **Device Settings** | **Date/Time**.

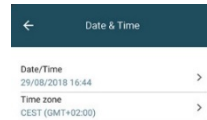

▶ Various setting options are displayed. Depending on your requirements, you can

- Enable (●) / disable (▶) selection fields by tapping
- Open other selection fields
- Enter parameters using the keypad
- Set 24 hr or AM/PM format: 24 hr (●) / AM/PM (▶)

2 Back to the **Device Settings** menu: Tap  |  | .



**Set Date/Time manually**

1 Tap **Date/Time**.

2 Tap **Autom. Date/Time**.

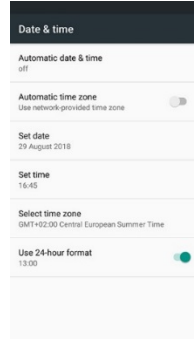

3 Select **Off**.

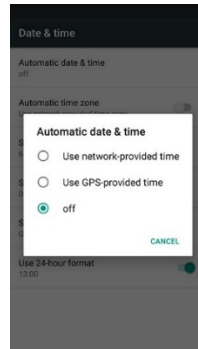

▶ **Autom. Date/Time** is disabled. The pop-up window closes automatically.

4 Tap **Set Date**.

5 Select date via the calendar and confirm with **OK**.

6 Tap **Set Time**.

7 Tap hour and set.

8 Tap minute, set and confirm with **OK**.

9 Back to the **Device Settings** menu: tap  |  | .

### Set time zone manually

- 1 Tap **Time Zone**.
- 2 Tap **Autom. Time Zone** and disable (➡).
- 3 Tap **Select time zone**.
- 1 Select desired time zone.
- 2 Back to the **Device Settings** menu: tap ⏪ | ⬅ | ⏩.

### 8.2.5.4 Own company address

Enter own company address. This information will be shown on the reports.

- 1 Call up function: ☰ | **Device Settings** | **Own company address**
  - ▶ **Contact information** input screen is opened.
- 2 Tap the required input field.
  - ▶ Keypad appears.
- 3 Enter the information via the keypad.
- 4 Confirm each input with ✓.
- 5 Back to the **Device Settings** menu: tap ⏪.

### 8.2.5.5 Bluetooth

Enable Bluetooth in order to print out or transmit measurement data.





- 1 Call up function: ☰ | **Device Settings** | **Bluetooth®**
- 2 Enable/disable **Bluetooth** by tapping the selection field.
- 3 Back to the **Device Settings** menu: Tap ⏪.

### 8.2.5.6 Hotspot

Enable a hotspot in order to be able to transmit readings to software / industry software.





The interface must also be available in the software / industry software.

- 1 Call up function:  | **Device Settings** | **Hotspot**
- 2 By tapping the selection field, enable ()/disable () **Hotspot**.
- 3 Back to the **Device Settings** menu: tap .

#### Edit hotspot name and password

- 1 Tap **Hotspot settings**.
- 2 Select **Wireless LAN Hotspot**.
- 3 Tap **Set up Wireless LAN Hotspot**.
- 4 Edit network name and password.
- 5 Tap **Save**.
- 6 Back to the **Device Settings** menu: tap .

### 8.2.5.7 Display brightness

- 1 Call up function:  | **Device Settings** | **Display brightness**
- 2 Adjust the display brightness using the slide control.
- 3 Back to the **Device Settings** menu: tap .



### 8.2.5.8 CO/NO sensor protect

Limit values can be set to protect the CO/NO sensors against overload. Sensor protect is enabled if these are exceeded:

- Fresh air dilution if exceeded (only for instruments with the "Dilution" option)
- Shutdown if exceeded again



When dilution is enabled, the CO and CO undiluted values are displayed in a blue font. A "\*" is shown on the printout after the name of both values to indicate dilution.



- 1 | Call up function:  | **Device Settings** | **Sensor Protect**
  - ▶ **CO** input screen: **Set Sensor Setting** is opened.
- 2 | Enter the alarm limit value via the keypad.
- 3 | Confirm input with .



The limit values must be set to 0 ppm to disable sensor protect.

### 8.2.5.9 O<sub>2</sub> reference

The O<sub>2</sub> reference value of the current fuel can be set.

- 1 | Call up function:  | **Device settings** | **O<sub>2</sub> reference**
  - ▶ **O<sub>2</sub> reference current fuel** input screen is opened.
- 2 | Enter the value via the keypad.
- 3 | Confirm input with .
- 4 | Tap [OK].

### 8.2.5.10 Alarm limits

Alarm limits can be set for the **CO Ambient** measurement type. An audible alarm signal is triggered when the alarm limit is reached.

- 1 | Call up function:  | **Device Settings** | **Alarm limits**
  - ▶ **Alarm limits** input screen is opened.

- 2 | Tap directly on the value in the relevant input field.
- ▶ | Keypad appears.
- 3 | Enter the value via the keypad.
- 4 | Confirm each input with ✓.
- 5 | Tap [OK].

### 8.2.6 Sensor diagnosis

Overview of the sensors fitted and their condition.

- 1 | Call up function:  | **Sensor Diagnosis**

### 8.2.7 Error list

Call up error reports.

- 1 | Call up function:  | **Error list**

### 8.2.8 Device information

Call up device information.

- 1 | Call up function:  | **Device information**

### 8.2.9 Server information

Information about the available server.

- 1 | Call up function:  | **Server information**

### 8.2.10 E-mail

#### Set up e-mail account

---



An e-mail account has to be set up in order to be able to send reports as e-mails. A Wireless LAN connection must be available to set the account up.

---

- 1 | Call up function:  | **E-Mail**
  - 2 | Enter e-mail address.
  - 3 | Enter password.
  - 4 | Set account options, such as synchronization interval
  - 5 | Entry of account name (optional) and name which appears with the sent e-mails.
- ▶ The inbox of the e-mail account is opened.
- 



If the system does not accept the e-mail address and password combination, but you are certain it is correct, check the following possible solutions:

- Open e-mail client, e.g. gmail, on a PC and check e-mail reception. The provider may have sent a security e-mail which has to be confirmed before the e-mail account on the testo 300 is accepted.
  - Enable IMAP account  
To do this, call up your e-mail account on the PC. You will find the setting for the common e-mail providers, e.g. gmx, under settings - POP/IMAP. Account-specific information about the enabling of the IMAP account is supplied by the relevant provider. Find out about this from the relevant provider or on the Internet.
  - Manual set-up of the e-mail account
    1. Call up function:  | **E-Mail**.
    2. Enter e-mail address.
    3. Select **Manual set-up**.
    4. Select **Personal account type (IMAP)** (recommended).
    5. Enter password.
    6. Enter/change server, port and security type.  
This information is e-mail account specific and is supplied by your e-mail account provider. Find out about this from your account provider or on the Internet.
-

- 
7. [Next]
  8. Enter/change smtp server, port and security type.  
This information is e-mail account specific and is supplied by your e-mail account provider. Find out about this from your account provider or on the Internet.
  9. [Next]
  10. Set account options, such as synchronization interval.
  11. [Next]
  12. Entry of account name (optional) and name which appears with the sent e-mails.
  13. [Next]
- ▶ The inbox of the e-mail account is opened.
- 

### Call up e-mail account

1 | Call up function:  | E-Mail

▶ | **Inbox** menu is opened.

2 | Create e-mail: tap .

▶ | **Compose** menu and the keypad is opened.

3 | Enter the e-mail address via the keypad.

4 | Fill in subject and create text.



If required, additional files can be attached to the e-mail using the paper clip symbol.

5 | Send e-mail: tap .







▶ | E-mail is sent.

## 8.2.11 My Apps

Additional applications

1 | Call up function:  | **My Apps**

▶ Available Apps are displayed.

Symbol	Name
	Alarm clock
	Gallery
	Browser
	Calendar
	Calculator
	Quick Support

## 8.2.12 Help

### 8.2.12.1 Device registration

1 | Call up function:  | **Help | Device Registration**

Testo would like to offer you the best possible customer service. Register your instrument so that, when you call, our employees in Customer Service have all the information they need available at all times, so that they can quickly provide you with further assistance.

Register at: <https://testo.com/register>

You will find the information you need for registration on the sticker on the back of the instrument.

Follow the instructions on the display.

Registration gives you the following advantages:

- 1 year's additional warranty for free
- Always being up to date with the latest from Testo



### 8.2.12.2 Tutorial

- 1 | Call up function:  | **Help** | **Tutorial**

The tutorial provides you with an overview of and an introduction to the operation and functions of the instrument.

### 8.2.12.3 Setup Wizard

- 1 | Call up function:  | **Help** | **Setup Wizard**
- 2 | The following settings can be made:

Function	Section
Country version and language	8.2.5.2
Wireless LAN	8.2.5.2
Time	8.2.5.3
Contact information	8.2.5.4 (Own company address)
Registration	8.2.11.1 (Device Registration)

- 3 | **Next** >
- ▶ | Setup is complete.
- 4 | If necessary, tap **start tutorial** or **end setup**.

### 8.2.12.4 Update via USB



Testo recommends updating the firmware only when the charge capacity is full.

You will find the current instrument software (firmware) on the Testo homepage [www.testo.com](http://www.testo.com) under the product-specific downloads.

- 1 | Call up function:  | **Help** | **Update via USB**
- 2 | Confirm info with **OK**.
- ▶ | Firmware update is started.

- 3 | Insert the connecting cable (0449 0134) into the USB port on the measuring instrument, then connect it to the PC.
  - ▶ | Your PC identifies the measuring instrument as a removable medium.
- 4 | Copy the new instrument software file (t300.zip) to the identified removable medium.  
Length of the copying process: approx. 10 – 15 minutes
- 5 | Disconnect the connecting cable from the measuring instrument.
  - ▶ | Once the instrument software has been updated (duration approx. 1.5 hrs), the measuring instrument will automatically reboot and is ready for use again.

## 9 Performing the measurement

### 9.1 Prepare for measurement

- 1 | Check the condensate container fill level and if necessary empty container, see Section 10.5 **Empty condensate trap**.
- 2 | Check the particle filter of the flue gas probe for contamination and replace it in good time. If necessary, see Section 10.10 **Check/replace particle filter**.

### 9.2 Zeroing phases

#### Measuring the combustion air temperature (AT)

If no external combustion air temperature probe is connected, the combustion air temperature is measured via the integrated temperature probe.

#### Gas zeroing

The gas sensors are automatically zeroed after the instrument is switched on.



---

#### **testo 300 without option of probe zeroing in the flue gas:**

The flue gas probe must be in fresh air during the zeroing phase (30 sec)!

#### **testo 300 without option of probe zeroing in the flue gas:**

The flue gas probe may already be in the flue gas duct during the zeroing phase (30 sec).

---

- > | Start zeroing of the gas sensors manually:  | **Zeroing Gas Sensors**

### Draught/pressure zeroing

The pressure sensors are zeroed when a pressure measuring function is called up.



#### **testo 300 without option of probe zeroing in the flue gas:**

The flue gas probe must be in fresh air during the zeroing phase! The instrument must not be pressurized during zeroing!

#### **testo 300 without option of probe zeroing in the flue gas:**

The flue gas probe may already be in the flue gas duct during the zeroing phase. The pressure socket of the instrument must be free (depressurized, not closed).

## 9.3 Carry out gas path check



Regularly check the measurement system (measuring instrument + flue gas probe) for leaks.

In particular, too high an O<sub>2</sub> value may be an indicator of a leaking measurement system.

>  | Gas path check.

## 9.4 Use of flue gas probe

### Check thermocouple before use

- > The thermocouple of the flue gas probe must not be touching the probe cage.  
Bend the thermocouple back if necessary.

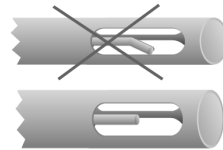

### Align flue gas probe

- > The thermocouple must be freely exposed to the flue gas flow.  
Align the probe by turning it as required.

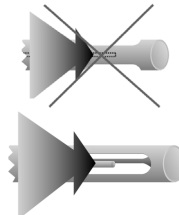

### Search for corestream

✓ The tip of the probe is in the corestream of the flue gas.

1 Select **Corestream**.

2 Start corestream search: tap .

3 Perform zeroing. Please follow the instructions.

4 Align the flue gas probe in the flue gas duct so that the probe tip is in the corestream (area of the highest flue gas temperature Max FT).

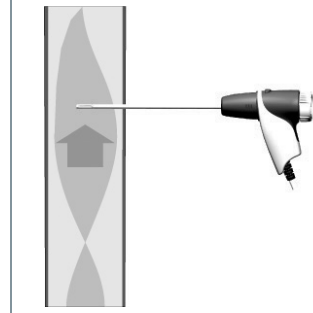

▶ Grey value/grey pointer: Display of current flue gas temperature

▶ Orange value/orange pointer: Display of maximum flue gas temperature

> Reset values/pointer: .

5 End corestream search: tap .

## 9.5 Overview of measurement types ( )

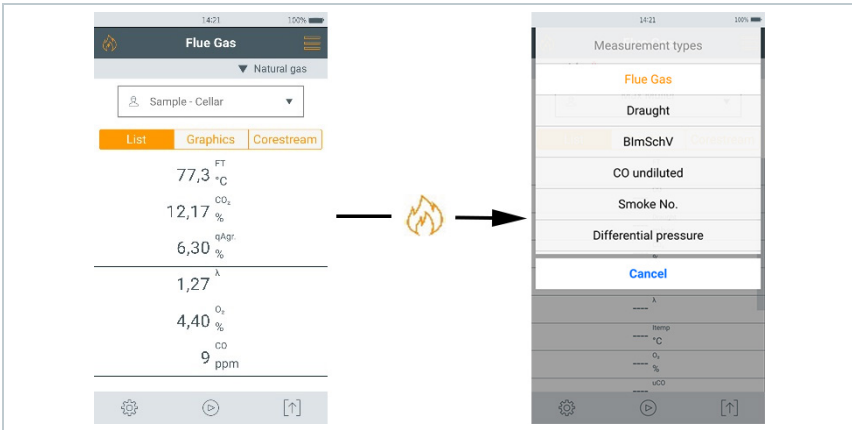

Measurement types
Flue gas
Draught
BlmSchV
CO undiluted
Smoke No.
Differential pressure
Differential temp.
O <sub>2</sub> Air
Gas flow
Oil flow
CO ambient
Tightness test 1
Tightness test 2
Let by test
4 Pa measurement

### 9.5.1 Flue gas



In order to maintain the measuring accuracy of the instrument, the correct fuel must be selected or configured.

Tap ▼ (Fuels)  
> Select fuel.



To achieve usable measurement results, the test time of a flue gas measurement should be at least 3 minutes and the measuring instrument should display stable readings.



If a separate **CO undiluted** measurement has not yet been carried out, this value is calculated using the readings from the flue gas probe and continuously updated.



For this type of measurement, the **Mean value calculation** option is also available. See **Mean value calculation** section.

- 1 Call up function:  | **Flue Gas**

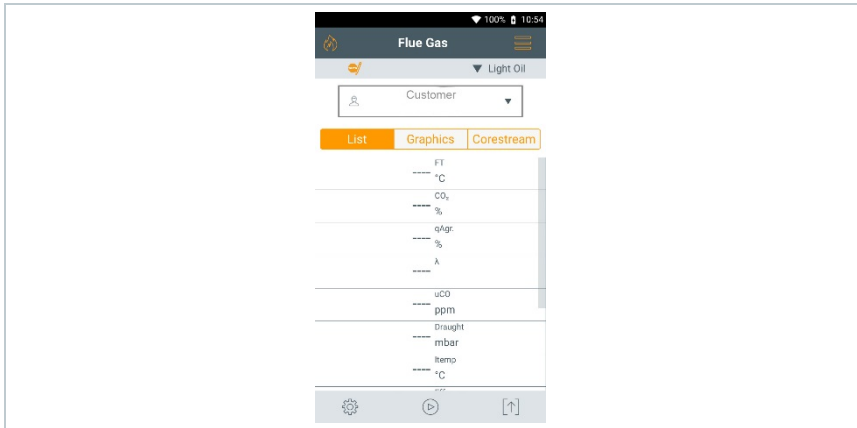

- 2 Start measurement: Tap .

- ▶ Zeroing takes place.
- ▶ Readings are displayed.



If the **Draught** measurement parameter is enabled in the reading display, a draught measurement is automatically started in parallel to the flue gas measurement. In the **List** measurement data view, the

parallel draught measurement can be stopped/restarted. This draught measurement is performed separately to a measurement of the **Draught** measurement type.



For the draught measurement, the minus connection for differential pressure measurement must be free (ambient pressure, not closed).

- 3 Tap on the draught reading display or next to it.
- 4 End measurement: tap .

## 9.5.2 Draught



For this type of measurement, the **Mean value calculation** option is also available. See **Mean value calculation** section.

- ✓ A flue gas probe must be connected.

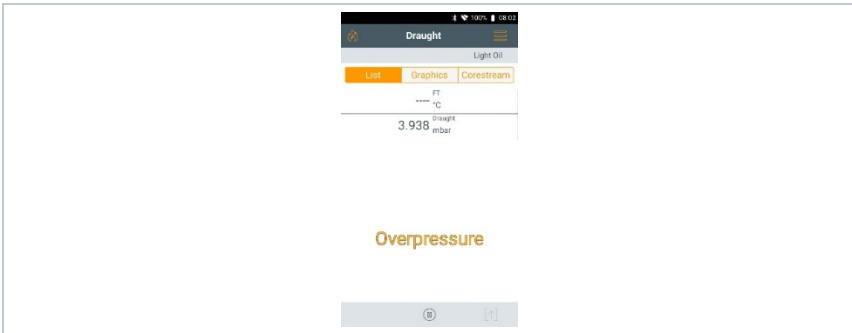

- 1 Call up function: | **Draught**



The minus connection for differential pressure measurements must be clear (ambient pressure, not closed).

- 2 Start measurement: tap .
- ▶ Zeroing takes place. Please follow the instructions.
- ▶ Reading is displayed.
- 3 End measurement: tap .

### 9.5.3 CO undiluted

- ✓ A multi-hole probe (0554 5762) must be connected.
- 1 Call up function:  | **CO undiluted**
- 2 Start measurement: tap  .
- ▶ Reading is displayed.
- 3 End measurement: tap  .

### 9.5.4 Smoke number





The **Smoke No.** and **Oil depos.** parameters are only available for oil fuels. The values calculated by a smoke tester can be entered.

#### Edit values

---



All values that can be modified have a dotted underlining.

- 1 Call up function:  | **Smoke No.**
- 2 Tap required value.
- ▶ Keypad appears.
- 3 Enter value.
- 4 Confirm entry: tap ✓.
- 5 Reset readings: tap  .



## 9.5.5 Differential pressure



For this type of measurement, the **Mean value calculation** option is also available. See **Mean value calculation** section.

### WARNING

**Dangerous mixture of gases!**

**Danger of explosion!**

- Make sure there are no leaks between the sampling point and the measuring instrument.
- Do not smoke or use naked flames during the measurement.

- ✓ The gas pressure kit (0554 1203) must be connected.
  - ✓ For an instrument with no dilution option: The minus connection for differential pressure measurement must be depressurized at the start of the measurement (ambient pressure, instrument not connected to system being checked), since the pressure sensor is zeroed.
- 1 Call up function: | **Differential pressure**
  - 2 Tap **Differential pressure**.
  - 3 Start measurement: tap .
    - ▶ Zeroing the pressure sensor.
    - ▶ Reading is displayed.
  - 4 End measurement: tap .

### 9.5.6 Differential temp.



For this type of measurement, the **Mean value calculation** option is also available. See **Mean value calculation** section.

---

- ✓ Two external temperature probes must be connected.
- 1 Call up function: | **Differential temp.**
- 2 Start measurement: tap .
- ▶ The readings and the calculated differential temperature  $\Delta t$  (T1 - T2) are displayed.
- 3 End measurement: tap .

### 9.5.7 O<sub>2</sub> supply air

- ✓ An O<sub>2</sub> dual wall clearance probe (0632 1260) must be connected.
- 1 Call up function: | **O<sub>2</sub> supply air**
- 2 Start measurement: tap .
- ▶ Reading is displayed.
- 4 End measurement: tap .

### 9.5.8 Gas flow





The function is only available if the chosen fuel is a gas.

---

The gas burner capacity is calculated by means of the gas amount consumed. To this end, a gas amount is input and its consumption read out at the gas meter.

- 1 Call up function: | **Gas Flow**
- 2 Set the gas amount to watch for at the gas meter.
- 3 Set the calorific value of the burnt gas.

- 4 | Start measurement: tap .
- ▶ The test time is displayed.
- 5 | When the set gas amount is reached: tap .
- ▶ The calculated gas flow and the gas burner capacity (in KW) are displayed.

### Edit values

---



All values that can be modified have a dotted underlining.

---

### 9.5.9 Oil flow rate

---



The function is only available if the chosen fuel is an oil.

---

This function is used to calculate the capacity of the burner from the set oil pressure and the oil flow rate of the oil nozzle.

- 1 | Call up function:  | **Oil flow rate**
- 2 | Set oil flow rate of the oil nozzle and oil pressure.
- ▶ The calculated oil burner capacity is displayed (in KW).

### Edit values

---



All values that can be modified have a dotted underlining.

---

### 9.5.10 CO ambient

---



- Cigarette smoke influences the measurement by more than 50 ppm. The breath of a smoker influences the measurement by about 5 ppm.
  - When using an ambient CO probe, note that:  
The direction of flow of the gas has an effect on the accuracy of measurement. Frontal flow onto the sensor leads to higher readings. The best measurement results are achieved when the probe is moved gently backwards and forwards.
  - When using the ambient CO probe and the flue gas probe, note that:  
The probe must be in the fresh air (CO-free) during the zeroing phase.
-



For this type of measurement, the **Mean value calculation** option is also available. See **Mean value calculation** section.

- ✓ An ambient CO probe (0632 1272) must be connected.
- 1 Call up function: | **CO Ambient**
- 2 Start measurement: tap .
- ▶ Reading is displayed.
- 3 End measurement: tap .

### 9.5.11 Tightness test 1

The tightness test 1 (using air or inert gas such as CO<sub>2</sub> or N<sub>2</sub>) is a tightness test for pipes, including fittings, but without gas appliances and the relevant regulating and safety devices. The tightness test 1 is carried out after a load test has been successfully completed on newly laid gas pipes, or after renovation of existing gas pipes, and is used for the acceptance of these pipes. It shows up even the smallest leaks in gas pipes.



According to DVGW TRGI 2018 and ÖVGW G10, the stabilization time and test time depend on the pipe volume.

- Pipe volume < 100 l: Adjustment time 10 min, test time 10 min.
- Pipe volume > 100 l to < 200 l: Adjustment time 30 min, test time 20 min.
- Pipe volume > 200 l: Adjustment time 60 min, test time 30 min.

- > Connect the connector plug of the hose pressure connection kit (0554 1203) to the pressure test kit (0554 1213). Insert the pressure adapter into the flue gas socket and lock by slightly turning it clockwise (bayonet fitting).

#### Carrying out the measurement

- ✓ The pressure socket of the instrument must be free (depressurized, not closed).
- ✓ Pressure zeroing has been carried out.
- 1 Call up function: | **Tightness test 1.**

- 2 Set parameters or enter values.



All values that can be modified have a dotted underlining.

- 3 Pressurize the system.



Once the pressure has built up, a stabilization time specified by DVGW-TRGI 2018 should be observed to ensure that any possible pressure fluctuations are not recorded in the measurement as well. The relevant standard provides more detailed information.

- 4 Start stabilization time: tap . If applicable, follow instructions.

▶ Reading is displayed.

▶ Stabilization time is finished.



End stabilization time early: tap .

▶ Measuring time starts.

▶ The readings are automatically saved and displayed after the measurement has been completed.

- 5 The measuring value result can be assessed.

- 6 Conclude measurement: tap **Next**.

- 7 If applicable, repeat measurement: tap .

### 9.5.12 Tightness test 2

This measurement is carried out to test the serviceability of an existing gas pipe system (in contrast to the load test and tightness test 1) and is used to check the actual condition of the pipes. The pipe system may be in operation or disused.



Adhere to DVGW-TRGI 2018, worksheet G624!

Absolute pressure (parameter of the measuring location) must be entered to obtain correct readings. If this is not known, it is advisable to use the value 966 hPa (corresponds to 1013 hPa barom. 400 m above sea level).



testo 300 is not approved according to DVGW G5952 and therefore no official usability test according to DVGW-TRGI 2018 may be carried out with the device. For this measurement, we recommend testo 324, which has been tested and approved according to DVGW G5952 by DVGW Karlsruhe and also according to ÖVGW Guideline 1/2.

---

- > Insert the connector plug of the hose pressure connection kit (0554 1203) into the flue gas socket and lock it in place by turning it slightly clockwise (bayonet fitting).

### Carrying out the measurement

- ✓ The pressure socket of the instrument must be free (depressurized, not closed).
- ▶ Pressure zeroing has been carried out.
- 1 Call up function:  | **Tightness test 2**
- 2 Set parameters or enter values.



All values that can be modified have a dotted underlining.

---



Three circle diameters and three pipe lengths can be entered, which are then used to calculate three partial volumes. The pipe volume is calculated by adding these three partial volumes.

---

- 3 Pressurize the system.
- 4 Start stabilization time: tap  . If applicable, follow instructions.
- ▶ Reading is displayed.
- ▶ Stabilization time is finished.



End stabilization time early: tap  .

---

- 5 End measurement: tap  .
- ▶ Measuring time starts.
- ▶ The readings are automatically saved and displayed after the measurement has been completed.

- 6 | The measuring value result can be assessed.
- 7 | Conclude measurement: tap **Next**.
- 8 | If applicable, repeat measurement: tap ↺.

### 9.5.13 Let by test

- > Insert the connector plug of the hose connection kit (0554 1203) into the flue gas socket and lock it in place by turning it slightly clockwise (bayonet fitting).

#### Carrying out the measurement

- ✓ The pressure socket of the instrument must be free (depressurized, not closed).
  - ✓ Pressure zeroing has been carried out.
- 1 | Call up function: 🔥 | **Let By Test**.
  - 2 | Set parameters or enter values.
 

---

 All values that can be modified have a dotted underlining.

---
  - 3 | Start stabilization time: tap ⏪. If applicable, follow instructions.
    - ▶ Reading is displayed.
    - ▶ Stabilization time is finished.

---

 End stabilization time early: tap ⏩.

---

    - ▶ Measuring time starts.
    - ▶ The readings are automatically saved and displayed after the measurement has been completed.

- 4 | The measuring value result can be assessed.
- 5 | Conclude measurement: tap **Next**.
- 6 | If applicable, repeat measurement: tap .

### 9.5.14 4 Pa measurement

---



The 4 Pa measurement is only available with instruments that have the **dilution** option available.

---

1 | Call up function:  | **4 Pa measurement**

2 | Set parameters or enter values.



All values that can be modified have a dotted underlining.

---

3 | Connect adapter 0554 1203, hose connection kit and capillary hoses 0554 1215 as shown in the illustration.

4 | Tap **Next**.

▶ Hose test is started.

5 | Tap **Next**.

▶ Measurement starts.

▶ Readings and measuring time are displayed.



Follow the notes in the display.

---

▶ The readings are automatically saved and displayed after the measurement has been completed.

6 | End measurement early: tap .



### **Guidelines for the qualification test for differential pressure measuring instruments for the measurement of underpressures in rooms where firing installations are set up**

These guidelines were created by the ZIV (Guild of Master Chimney Sweeps) in collaboration with differential pressure measuring instrument manufacturers, the TÜV SÜD Industrie Service GmbH test centre, firing and heat technology, and the DVGW (German Technical and Scientific Association for Gas and Water).

Areas of application and purpose:

Firing installations which are dependent on indoor air must not be set up in rooms with air extraction equipment. However, insofar as no dangerous underpressure can arise while the firing installations are in operation, derogations are possible. An underpressure of more than 4 Pa should be regarded as dangerous when operating firing installations which are dependent on indoor air. When operating tested firing installations which are not dependent on indoor air for solid fuels, as a rule an underpressure of more than 8 Pa is not permissible (see proof of usability e.g. general building approval for the firing installation). These test guidelines apply to differential pressure measuring instruments for determining the underpressure in rooms where firing installations are set up and is aimed at the manufacturers of these kinds of measuring instruments. They set out requirements for construction and minimum requirements for the performance characteristics of relevant measurement and inspection equipment in the area of underpressure measurement, along with specifications for carrying out qualification tests.

Description of typical measuring principles:

With an instrument that has been tested according to these guidelines, it is possible to check an underpressure limit value of 4 Pa, or of 8 Pa for firing installations which are not dependent on indoor air, in the equipment room, and to show the time progression over a period of at least 3 minutes in a diagram on the display, or to print it out, and evaluate it. Two flexible capillary hoses of the same length enable the differential pressure between the equipment room and a reference point that is pneumatically disconnected from the combustion air network (outside air, stairwell) to be recorded and conveyed to a pressure sensor.

The capillaries can be routed both outside through the window sealing and to the stairwell through the door rebate or the keyhole. The second capillary hose remains in full in the equipment room.

Procedure for an underpressure measurement in equipment rooms:

Firing installations which are dependent on indoor air must not be set up in rooms with air extraction equipment. However, insofar as no dangerous underpressure can arise while the firing installations are in operation, derogations are possible. An underpressure of more than 4 Pa should be regarded as dangerous when operating firing installations which are dependent on indoor air. When operating tested firing installations which are not dependent on indoor air for solid fuels, as a rule an underpressure of more than 8 Pa is not

## 9 Performing the measurement

---

permissible (see proof of usability e.g. general building approval for the firing installation).

The proof can be provided through different measures. These for instance include the installation of a window tilt switch, the installation of an underpressure monitor or proof by means of measuring technology that with simultaneous operation of the fire installation(s) and indoor air extraction system(s), no dangerous underpressure can arise.

The question as to which measure may give the desired result essentially depends on the local conditions. These are for instance the leaktightness of the building shell, the size of the usage unit, the presence or leaktightness of the communicating doors and the quantity of air which is extracted from the usage unit by the indoor air extraction systems.

It can be assumed that, with effective fume hood systems, at least 400 m<sup>3</sup>/h of air are extracted (with exhaust air driers the quantity of air is not significantly below this, very powerful fume hood systems extract over 1000 m<sup>3</sup>/h of air). With very high air extraction performances, an underpressure measurement is frequently not expedient in apartments or comparable usage units.

As a rule, the solution here can simply be an opening to the outside, so for example a tilted window with a window tilt switch. In a case of this kind, the measurement only makes sense if the owner/operator of the firing installation is absolutely intent on having the proof of the underpressure being too high.

The area of application of underpressure measurement in equipment rooms is therefore primarily where the power of the indoor air extraction systems is estimated to be low or there are particular physical conditions which suggest that the underpressure does not exceed the permissible value (4 or 8 Pa) when the firing installation(s) and indoor air extraction system(s) are operated together.

The check that no dangerous underpressure can arise should be carried out using pressure measuring instruments that have undergone qualification testing for the "measurement of underpressures in rooms where firing installations are set up".

The measurement is carried out according to the following process outline:

1. Close all the usage unit's windows and doors. If there are blinds present on the windows and external doors, these should also be closed. Switch differential pressure measuring instrument on and wait for the zero point to be determined, connect capillary hoses to the measuring instrument (reference = (-) connection, equipment room = (+) connection), open windows, and if applicable blinds, and lay external capillary hose (for reference pressure), check zero point on the reading display, start pressure progression recording, wait approx. 30 seconds with open window or external door to register zero line.
2. Start up firing installation(s) and set to maximum power. For manually loaded firing installations for solid fuels, full load operation must be achieved. All available air extraction equipment should be started up. The process must involve the measurement recording the most unfavourable condition, that is

the evaluation should be carried out with the air extraction system(s) at the highest level of power. In cases where the ventilation equipment is not located in the same room as the firing installation, all doors and openings between the room where the firing installation is set up and the ventilation equipment are to be kept open. The zero point should not change after starting up the firing installation and air extraction equipment with the window or external door of the equipment room open.

3. Close door/window, wait approx. 30 seconds, check underpressure, check clean extraction of the flue gases. If a blind is present on the window/external door of the equipment room, this should be closed and opened at the same time in each case.
4. Open door/window, wait approx. 30 seconds, zero line must be reached again.
5. Close door/window, wait approx. 30 seconds, check underpressure, check clean extraction of the flue gases.
6. Open door/window, wait approx. 30 seconds, zero line must be reached again.
7. Close door/window, wait approx. 30 seconds, check underpressure, check clean extraction of the flue gases.

After the measurement, the result can be printed out and evaluated. If the underpressure in the room where the firing installation(s) is/are set up is constantly below 4 Pa, or with tested firing installations for solid fuels that are not dependent on indoor air below the maximum permissible underpressure specified in the proof of usability (currently 8 Pa in principle), then the safe simultaneous operation of the firing installation and air extraction system(s) is possible.

Careful execution of the measurement in accordance with the steps listed above enables a correct evaluation and rating of the safe operation of the firing installation(s) and indoor air extraction system(s).



The measurement result represents the evaluation of the current status, taking into account the devices available for the test and influencing the result (combustion plants and air extraction system(s)) and the condition of the building (e.g. windows and doors). A new evaluation is required when there is a change to the firing installation, to any other devices that have an influence or to the building.

Repeat checks:

Flawless operation of the instrument, the fine pressure probe and the capillary hoses must be determined by regular checks once every six months at a technical test centre of the Guild of Master Chimney Sweeps.

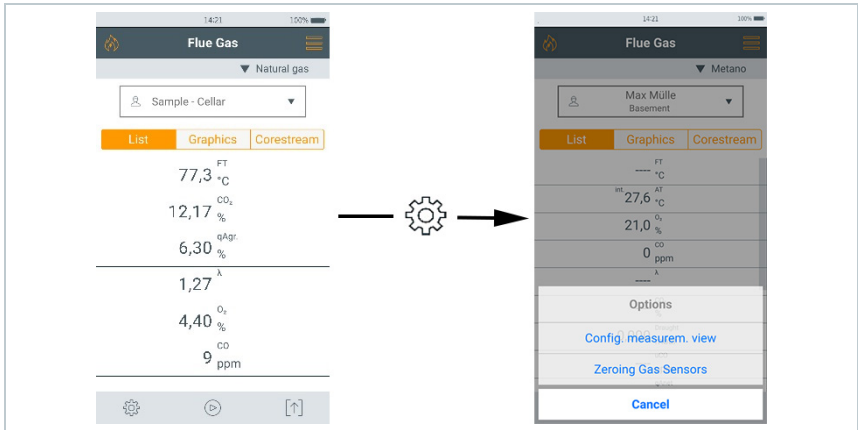
## 9.6 Overview of options ( )





Options	Description
<b>Edit measurement.View</b>	<b>Add, delete</b> (  ) , measurement parameters, display sequences (  ) and edit units (click on <b>Unit</b> ).
<b>Zeroing Gas Sensors</b>	Manually zeroing gas sensors.  Menu is only available for measurements with gas sensors.
<b>Averaging   On</b>	Calculation of a mean value within a preset time.

### 9.6.1 Edit view

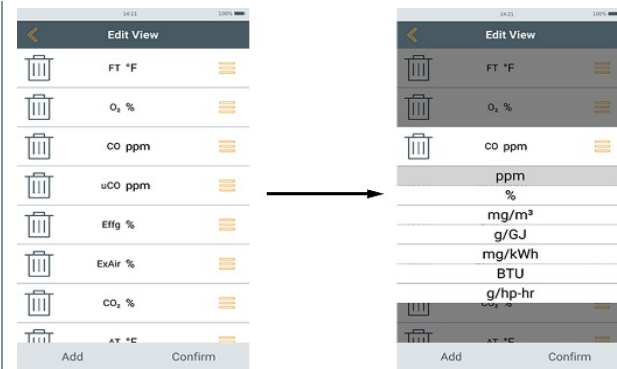
- 1 | Call up function:  | **Options** | **Edit View**
- ▶ | **Edit View** menu is opened.
- 2 | Measurement parameter



- **Add:** tap **Add** to open selection list of measurement parameters.
- **Delete:** tap on .
- **Edit unit:** tap on the measurement parameter you want to edit. Tap on the required measurement unit in the selection list that has been opened.
- Change position in the list: Press and hold  and drag to the required position.
- Accept changes: tap **Confirm**.

### Selection list (example: Country version Germany)

The overview of measurement parameters (available selection depends on the chosen measurement type, fuel set and the sensors available in the measuring instrument):

Display	Measurement parameter
FT	Flue gas temperature
AT	Combustion air temperature
ltemp	Instrument temperature
Pump	Pump performance
O2	Oxygen
CO2	Carbon dioxide
qAnet	Flue gas loss without consideration of the calorific value range
Effn	Efficiency without consideration of the heat value range
qAgr.	Flue gas loss with consideration of the calorific value range

Display	Measurement parameter
Effg	Efficiency with consideration of the calorific value range
Draught	Flue draught
$\Delta P$	Differential pressure
CO	Carbon monoxide
uCO	Undiluted carbon monoxide
NO	Nitrogen monoxide
NOx	Nitrogen oxides
$\lambda$	Fuel-air ratio
AmbCO	Ambient carbon monoxide
O2ref	Oxygen reference
$\Delta T$	Differential temperature
Dew Pt	Flue gas dewpoint temperature
Smoke 1	
Smoke 2	
Smoke 3	
Smokenumber $\emptyset$	



Only those measurement parameters and units that are enabled in the reading display appear in the reading display, in the saved measurement protocols and on the report printouts.



The settings only apply to the measurement type currently enabled.

## 9.6.1 Zeroing Gas Sensors

Zeroing of the gas sensors can be started manually.

- >  | Zeroing Gas Sensors
- ▶ The gas sensors are zeroed.



### **testo 300 without option of probe zeroing in the flue gas:**

The flue gas probe must be in fresh air during the zeroing phase (30 sec)!

### **testo 300 with option of probe zeroing in the flue gas:**

The flue gas probe may already be in the flue gas duct during the zeroing phase (30 sec).





## 9.6.2 Mean value calculation





The mean value calculation option is only available in the country versions x, y, z...



The mean value calculation option can only be set for the following measurement types: **Flue gas, Draught, Differential pressure, Differential temperature** and **CO Ambient**.

- 1 | Select required measurement type.
- 2 | Call up function:  | Options | Mean value calculation | On
  - ▶ The list for mean value calculation is opened.
  - ▶ The start button changes to .
- 3 | Determine the measuring rate (1 sec - 120 sec). The required value can be entered directly in the field on the first two lines of the display.
- 4 | Confirm with .
- 5 | Determine the measuring time (30 sec - 90 min). The required value can be entered in the field.
- 6 | Confirm with .

## 9 Performing the measurement

- 7 Start mean value calculation with .
- Stabilization time begins. It can be terminated manually by selecting **Next**.
  - After a maximum of 3 minutes, the stabilization time ends and the measurement starts automatically.
  - The system records the readings in the set measuring cycle.
  - During the measurement, the readings and the calculated values are displayed.
  - End measurement early: .
  - Readings are automatically saved.
  - The measurement result is displayed.
- 8 Carry out another measurement: .

### 9.7 Overview of protocols ( )

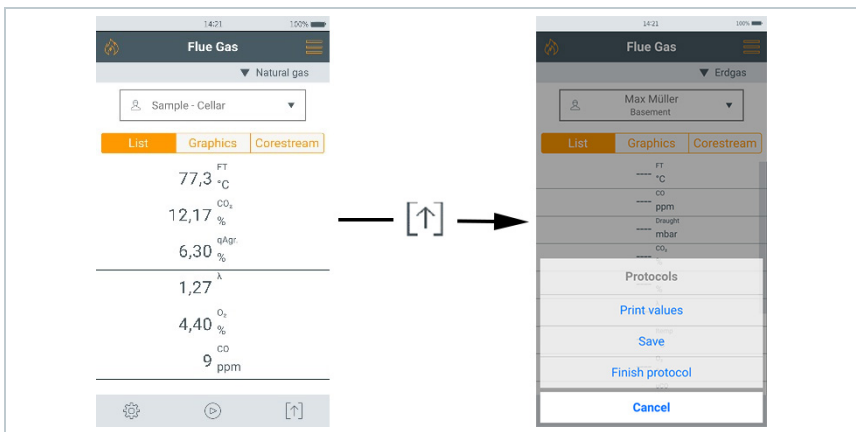

Protocols	Feature
<b>Print values</b>	Print out measuring values via Bluetooth®.
<b>Save</b>	Save measuring values, including selected customers / measuring sites. Saved measuring values can be retrieved in the main menu.



Protocols	Feature
Finish protocol	Create, save and send measurement report, including <ul style="list-style-type: none"> <li>- Own company data</li> <li>- Format and print</li> <li>- Customer data</li> <li>- Comments and pictures</li> <li>- Select measurements</li> <li>- Signature</li> </ul> Saved reports can be retrieved in the main menu.

## 9.7.1 Print data

The current readings are printed via a Bluetooth® printer (accessories: Testo printer 0554 0621).

### Carry out print text settings

Print text settings can be carried out and the reading printout can be supplemented with individual creator information (header: company address; footer: name of technician), see Section 8.2.5.4 **Own company address**.

### Print current readings

- ✓ | The printer is switched on and within wireless range.
- 1 | Tap [↑].
- ▶ | **Protocols** menu is opened.
- 2 | Tap **Print values**.
- ▶ | The protocol is created and sent to the printer.
- ▶ | The protocol is printed.

### 9.7.2 Save

The measurement data from the last measurement carried out of each measurement type are saved on the measuring instrument.

Measurements that have been carried out can be saved to back up the measurement data and for the subsequent creation of a report:

- 1 | Tap .
- ▶ | **Protocols** menu is opened.
- 2 | Tap **Save**.
- ▶ | The measurement protocol is saved.



Only saved readings can be further processed at a later stage for a report.









The readings are automatically saved for the following measurement types:

- Tightness test
- Tightness test 2
- Let by test
- 4 Pa measurement (DE country version)
- First German Federal Immission Control Ordinance (BlmSchV) (DE country version)
- Mean value calculation (IT country version)

---

### 9.7.3 Finish protocol

- 1 | Tap .
- ▶ | **Protocols** menu is opened.
- 2 | Tap **Finish protocol**.
- ▶ | Options for **Protocols** are opened.
- 3 | Enter/select log data:

Category	Description
<b>Format and print</b>	Select output format(s): <ul style="list-style-type: none"> <li>- <b>CSV</b> (comma separated text file, e.g. for Microsoft® Excel),</li> <li>- <b>PDF</b></li> <li>- <b>ZIV</b> (XML file, complying with the regulations of the 'Federal Association of Chimney Sweeps in Germany').</li> </ul>
<b>Customer data</b>	Enter contact details
<b>Comments and pictures</b>	Enter comments and <b>add</b> pictures.
<b>Select measurements</b>	<p>All saved measurements are displayed in one of the following time categories, depending on the creation date: <b>Today</b>, <b>Yesterday</b> or <b>Older</b>.</p> <p>The measurements selected to create the report are identified with . Recently saved measurements for these customers are automatically identified.</p> <p>To display saved readings to check them:</p> <ul style="list-style-type: none"> <li>➤ .</li> </ul> <p>To delete individual measurement:</p> <ul style="list-style-type: none"> <li>➤ .</li> </ul> <p>To delete all measurements of a time category:</p> <ul style="list-style-type: none"> <li>➤ Tap  next to the time category name.</li> </ul> <p>To select/deselect a measurement for the report:</p> <ul style="list-style-type: none"> <li>➤ .</li> </ul>
<b>Signature</b>	Tap <b>Sign Report</b> and sign. Options: <b>Abort</b> , <b>Reset</b> and <b>Save</b>

4

Print values: tap .

To save readings: tap .

Save and send report: tap .

# 10 Maintenance

## 10.1 Service

---



Testo recommends an annual check of the testo 300 which can be carried out by a service centre authorized by Testo. Please contact Testo at <http://www.testo.com> for more information.

---

## 10.2 Calibration

---



The measuring instrument is supplied with a calibration protocol as standard. In order to maintain the specified accuracy of the measurement results, Testo recommends having the testo 300 checked once a year by a Testo-authorized service centre.

Please contact Testo at <http://www.testo.com> for more information.

---

## 10.3 Check instrument status

### 10.3.1 Sensor diagnosis

The status of the sensors can be displayed.

To replace expended sensors, see Section "Replace sensors".

Call up function:  | **Sensor Diagnosis**

- ▶ Sensor diagnosis is displayed.
- 



A sensor is able to recover. It is therefore possible for the sensor status display to change from **not OK** to **OK**.

---

### 10.3.2 Error list

Instrument errors that have not yet been rectified can be displayed.

Call up function:  | **Error list**

- ▶ Error list is displayed if there are errors present.
- 

## 10.4 Clean the measuring instrument

- > If the housing of the measuring instrument is dirty, clean it with a damp cloth.
- 



Use distilled water, or alternatively mild solvents, such as isopropanol, to clean the flue gas analyzer.

---

**⚠ CAUTION****Improper use of isopropanol!****Irritation of the eyes and sensitive mucous membranes! Fumes have a slight narcotic effect!**

- If using isopropanol, please refer to the instruction leaflet for the product.
- When using it, please ensure that there is adequate ventilation.

**ATTENTION****Leaking solvents and degreasers!****Damage to the instrument and sensors!**

- Do not store solvents and degreasers, such as isopropanol, in the case.

**ATTENTION****Strong or harsh alcohol or brake cleaner!****Damage to the instrument!**

- Do not use any strong or harsh alcohol or brake cleaner.

## 10.5 Drain condensate container

The fill level of the condensate container can be read from the markings. Hold the instrument horizontally or vertically to check the fill level.

**⚠ CAUTION****Weak mix of acids in the condensate!****Minor injuries!**

- Avoid skin contact.
- Make sure that the condensate does not run over the housing.

**⚠ CAUTION****Condensate entering the gas path!****Damage to sensors and flue gas pump!**

- Do not empty condensate container while the flue gas pump is in operation.

- 1 Open the condensate outlet on the condensate container.



- 2 Let the condensate run out into a sink



- 3 - Wipe off any drops still on the condensate outlet with a cloth and close the condensate outlet.



The condensate outlet must be completely closed, otherwise incorrect measurements could occur due to infiltration of external air.

## 10.6 Open the measuring instrument

Only open the measuring instrument when this is required for maintenance purposes (replacing gas sensors).

- ✓ The measuring instrument must not be connected to a mains socket via the mains unit. The measuring instrument must be switched off.



When opening/assembling the instrument, take care not to lose any screws that have been removed. It is advisable to place a cloth on the work surface.

- 1 Place the instrument on its front so that the back is facing upwards.

- 2 Using a torx screwdriver (size T 10), remove both housing screws on the top of the instrument.



### ATTENTION

**The instrument may be damaged by incorrect removal of the housing screws!**

- Only remove the two housing screws on the top of the instrument. The other four screws must be left as they are.

- 3 Unlock the operating module in the direction of the arrow.

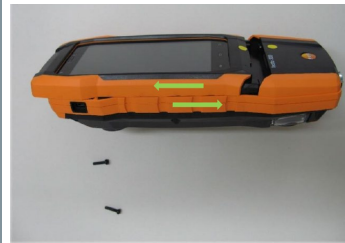

- 4 Remove the operating module.
- 5 Place the instrument on its front again.
- 6 Remove the remaining four screws on the back of the instrument.
- 7 Lift off the back of the instrument.

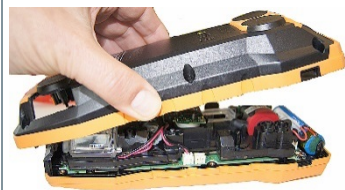

### Assembly



Perform in reverse order to assemble. Please note:

- Lay hoses and lines in the guides intended for this purpose.
- Make sure that hoses and lines do not get jammed.

## 10.7 Replace sensors



A slot bridge (0192 1552) must be inserted in slots which are not equipped with a sensor. Used sensors must be disposed of as hazardous waste!

Available slots:

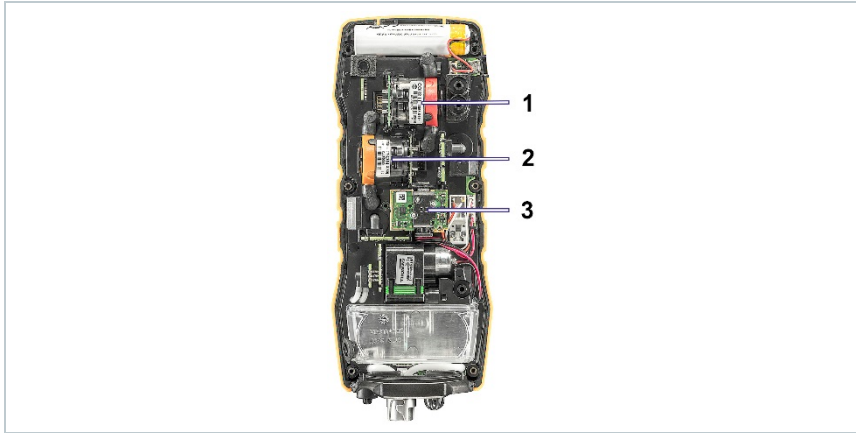

1	CO sensor or COlow sensor	3	O2 sensor
2	NO sensor or NOlow sensor		



When retrofitting a sensor, the associated measurement parameter/unit must be enabled in the reading display.



## 10.7.1 Replace O2 sensor

- ✓ Measuring instrument is open, see Section **Open measuring instrument**.

- 1 Unlock retaining bracket and open out.

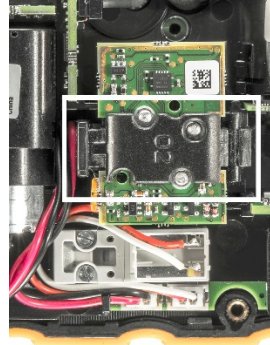

- 2 Remove faulty sensor from the slot.

- 3 Insert new sensor in the slot.

- i** Make sure that the socket on the sensor circuit board is correctly connected to the contact plug.

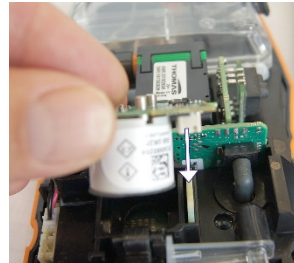

- 4 Close the retaining bracket with an audible "click".

- 5 Close the measuring instrument.



After replacing an O2 sensor, wait for an acclimatization time of 15 min to elapse before using the instrument.



When replacing an O2 sensor and when there is an interruption of the power supply for more than 10 hours, we recommend an acclimatization time of 1 hour for compliance with measuring accuracy.

## 10.7.2 Change CO, CO H2 and NO sensor

- ✓ Measuring instrument is open, see Section **Open measuring instrument**.

- 1 Remove faulty sensor and hose connections from the slot.

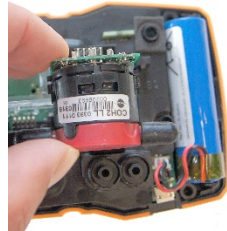

- 2 Remove hose connections from the faulty sensor/bridge.

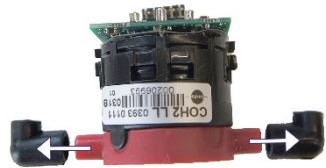

For NO sensor: Remove auxiliary circuit board.

Do not remove the auxiliary circuit board of the NO sensor until immediately before installation. Do not leave the sensor without auxiliary circuit board for longer than 15 minutes.

- 3 Fit the hose connections onto the new sensor.
- 4 Fit new sensor into the slot and at the same time fit the hose connections onto the gas path connections.



Make sure that the socket on the sensor circuit board is correctly connected to the contact plug.

- 5 Close the measuring instrument.

## 10.8 Clean modular flue gas probe

- ✓ Disconnect flue gas probe from the measuring instrument.
- 1 Release probe catch by pressing the key on the probe handle and remove probe module.
- 2 Blow compressed air through flue gas ducts of the probe module and probe handle (see illustration). Do not use a brush!
- 3 Fit probe module onto the probe handle and click into place.



## 10.9 Replace the probe module

- ✓ Disconnect the flue gas probe from the measuring instrument.
- 1 Press the key on the top of the probe handle and remove the probe module.
- 2 Fit new probe module and click into place.



## Check/replace particle filter

### Check particle filter

- Particle filters of the modular flue gas probe must be checked regularly for contamination: check visually by looking through the window of the filter chamber.
- If there is visible contamination or inadequate pump flow, replace the filter.

### Replace particle filter



The filter chamber may contain condensate. This is not a malfunction and will not cause incorrect readings.

- 1 Open filter chamber: turn slightly anti-clockwise.



- 2 Remove filter chamber.



- 3 Remove filter plate and replace it with a new one (0554 3385).

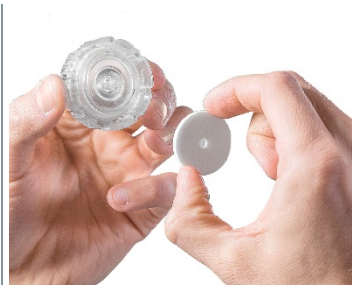

- 4 Attach the filter chamber and lock it: turn slightly clockwise.



## 10.10 Replace thermocouple

- 1 Release probe catch by pressing the key on the probe handle and remove probe module.
- 2 Remove thermocouple plug-in head from the socket using a screwdriver and pull thermocouple out of the probe shaft.
- 3 Insert new thermocouple into the probe shaft until the plug-in head clicks into place.
- 4 Fit probe module onto the probe handle and click into place.

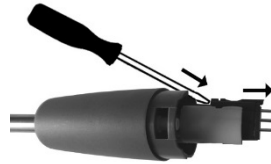

# 11 Technical data

Feature	Value
Temperature measuring instrument	-40 to +1200°C
Draught measurement	-9.99 to +40 hPa
Pressure measurement	-100 to 200 hPa
O <sub>2</sub> measurement	0 to 21 vol.%
CO measurement	0 to 4000 ppm
Option: CO measurement (H <sub>2</sub> -compensated)	0 to 8000 ppm
Option: CO measurement with activated fresh air dilution/measuring range extension	0 to 15000 ppm
Option: CO measurement (H <sub>2</sub> -compensated) with activated fresh air dilution/measuring range extension	0 to 30000 ppm
NO measurement	0 to 3000 ppm
Efficiency testing (Eta)	0 to 120%
Flue gas losses	0 to 99.9%
CO <sub>2</sub> determination (calculation from O <sub>2</sub> )	Display range 0 to CO <sub>2</sub> max.
Ambient CO measurement (internal/flue gas probe)	0 to 2000 ppm
Ambient CO measurement (external with CO probe)	0 to 500 ppm
Lifetime O <sub>2</sub> -sensor	up to 72 months, depending on the load
Lifetime CO-sensor	up to 72 months, depending on the load
Lifetime NO-sensor	up to 72 months, depending on the load

## General technical data

Feature	Value
Storage temperature	-20 to +50°C
Operating temperature	-5 to +45°C
Charging temperature	-0 to +45°C
Energy storage unit	3.6 V/3.5 Ah
Mains unit	5 V / 1 A
Humidity application range	15 to 90% RH, non-condensing

Feature	Value
Power supply	Energy storage unit, USB mains unit
Energy storage unit service life	10 hrs
Lifetime energy storage	> 1000 charging cycles / approx. 5 years
Protection class	IP 40
Memory	1 million measuring values
Display	5.0" touch display, HD 1280x720 pixels
Weight	Approx. 800 g
Dimensions	L: 244 mm (including probe connection) H: 59 mm W: 98 mm.
Certification	TÜV-tested according to 1st German Federal Immission Control Ordinance (BImSchV) EN 50379, Parts 1-3

## 12 Contact and support

If you have any questions or need further information, please contact your dealer or Testo Customer Service. For contact details, please visit [www.testo.com/service-contact](http://www.testo.com/service-contact).



**Testo SE & Co. KGaA**  
Celsiusstr. 1  
D-79822 Titisee-Neustadt  
Germany  
Phone: +49 7653 681-0  
E-mail: [info@testo.de](mailto:info@testo.de)  
[www.testo.com](http://www.testo.com)